

GREAT CASH ORDER HOUSE

Catalogue No. 15

OAK PINS

GALV. WIRE

CROSS ARMS

CEDAR POLES

GLASS INSULATORS

OAK BRACKETS



We Send Out No Agents

This Book is Our Salesman

RECEIVERS

BATTERIES

TELEPHONES

BACK BOARDS

TRANSMITTERS

MAGNETO BELLS



FARR TELEPHONE AND CONSTRUCTION SUPPLY CO., CHICAGO

Farr Telephone and Construction Supply Co.

(INCORPORATED)

C. W. FARR, PRESIDENT.

N. B. FARR, VICE-PRESIDENT.

R. J. CRAM, SECRETARY AND TREASURER.

DETROIT, MICH.

E. W. HURST, GENERAL MANAGER.

TERMS AND INSTRUCTIONS.

Our Prices are Low.

and based upon CASH SALES. No accounts opened unless first-class reference is furnished.

All accounts must be paid in thirty days.

Goods sent C. O. D. only when Express Charges are guaranteed.

The charges for return money on C. O. D. consignments are always added.

Goods sent C. O. D. by freight consigning same to ourselves. Collecting the bill through Bank with bill of lading and order for delivery attached to draft.

Actual Cost of Boxing.

Will be charged on goods, unless cash accompanies the order.

Guarantee...

Every set of Telephones furnished by us is guaranteed to be just what we claim for them and to work satisfactorily or money refunded.

We receive no returned goods unless we are notified and sanction same.

In ordering please state how goods are to be shipped, if by freight or express give name of route.

In remitting cash for goods to be sent by mail, send enough to pay postage.

No goods will be shipped C. O. D. to persons unknown to us, unless sufficient amount accompanies order to pay transportation charges.

We pack all goods with the utmost care, and receipts are obtained for all goods forwarded "in good condition," and our liability ceases when goods are delivered to carrier.

Persons having no account with us must send cash with order, or satisfactory reference to justify us in opening an account.

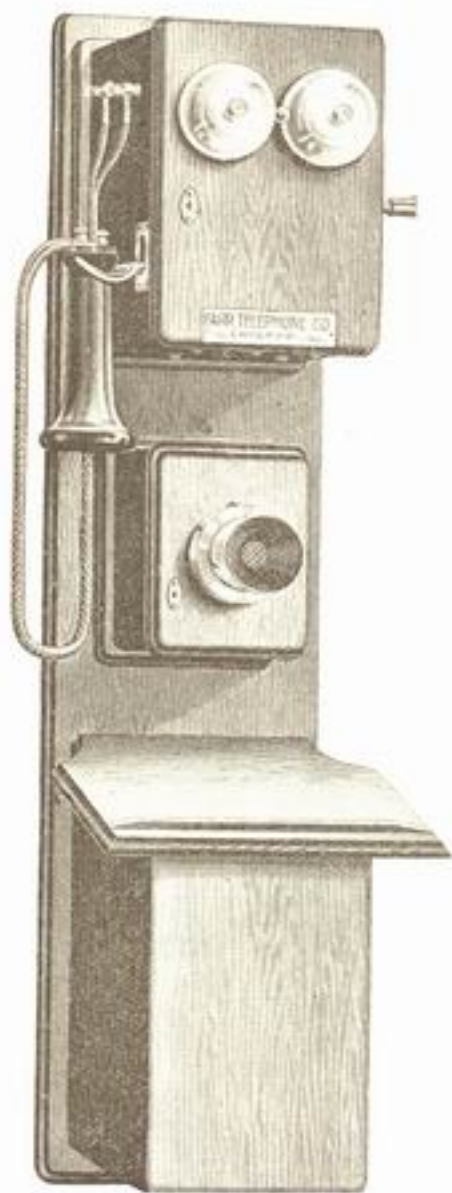

No. 1 TELEPHONE

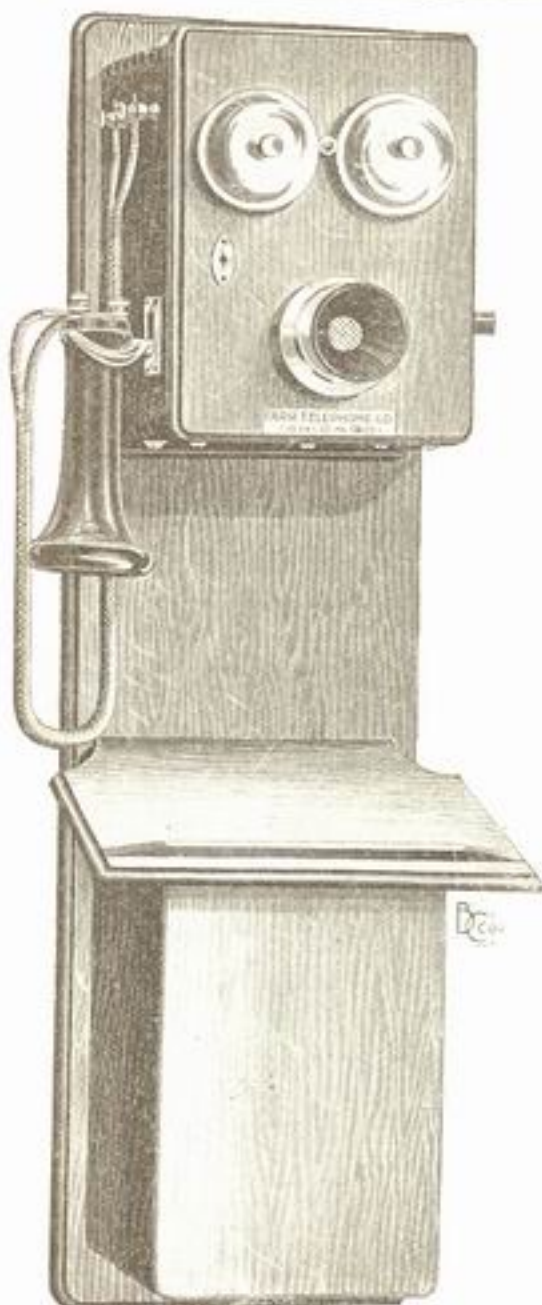

No. 2 TELEPHONE



No. 3 TELEPHONE



No. 4 ECHO TELEPHONE

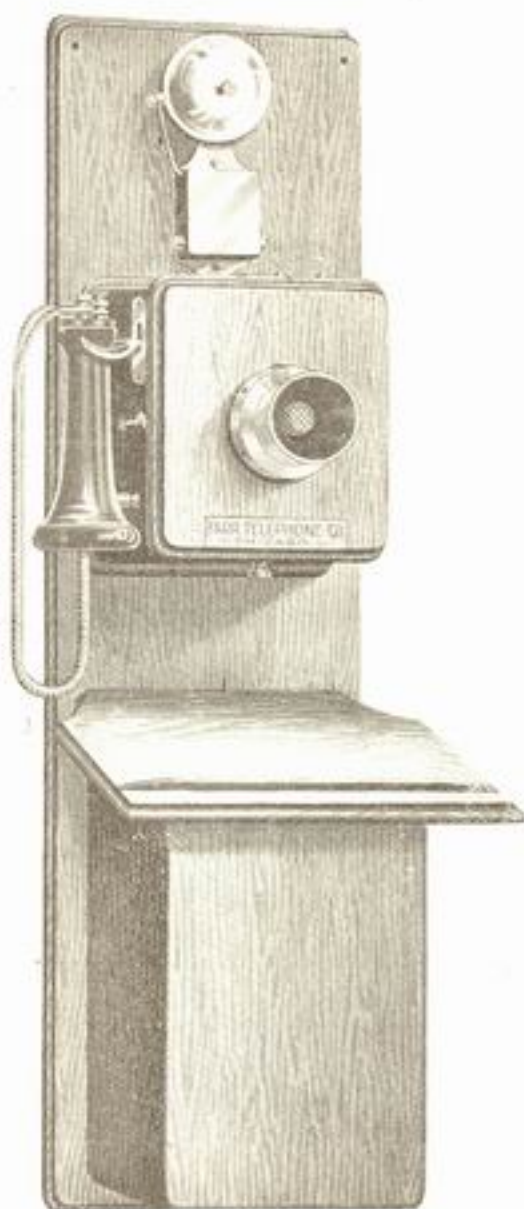

No. 5 TELEPHONE

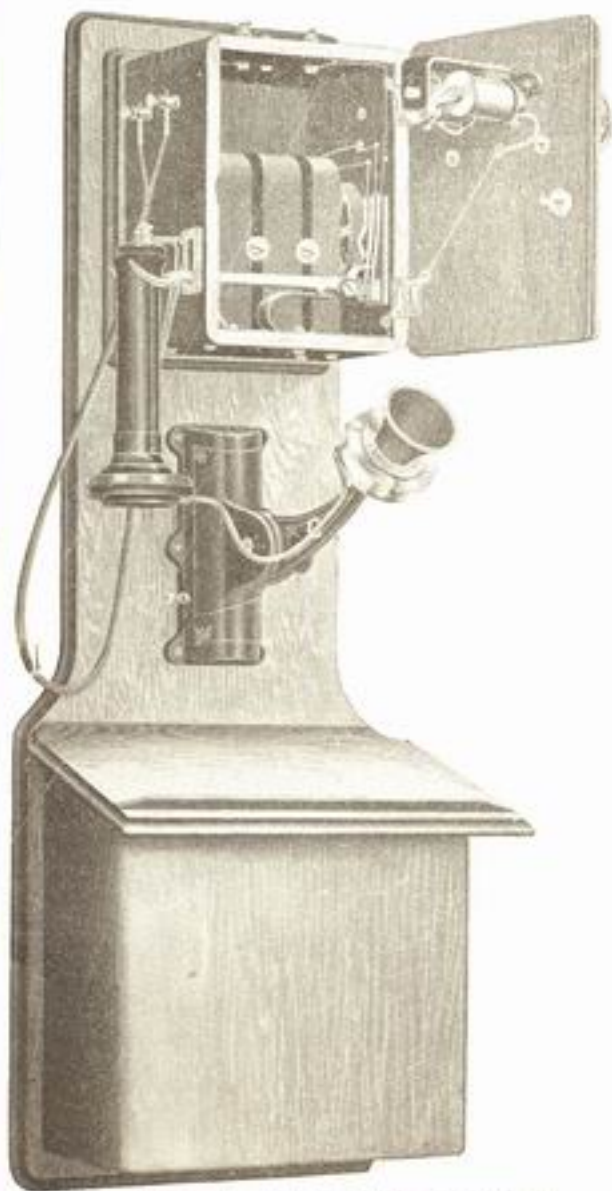

No. 6 and 7 TELEPHONE.

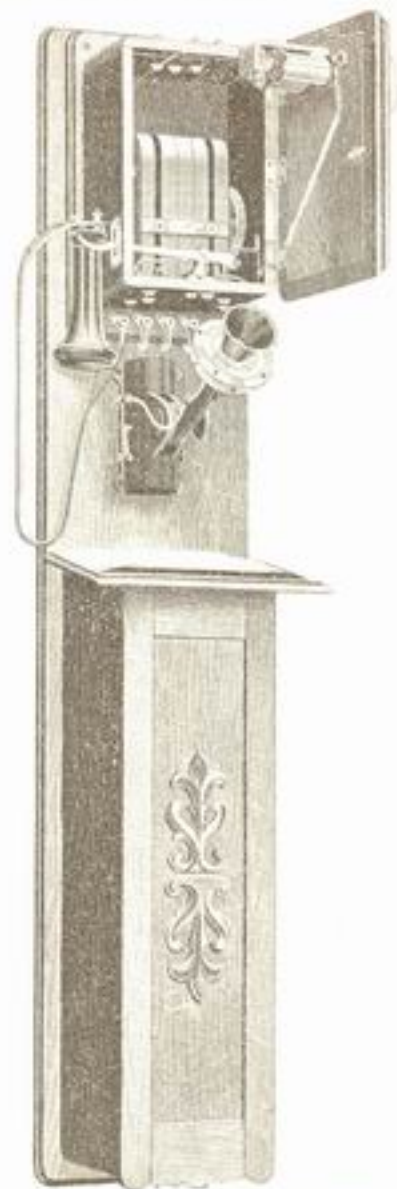

No. 9 TELEPHONE
Series.

No. 9A TELEPHONE
Bridging.

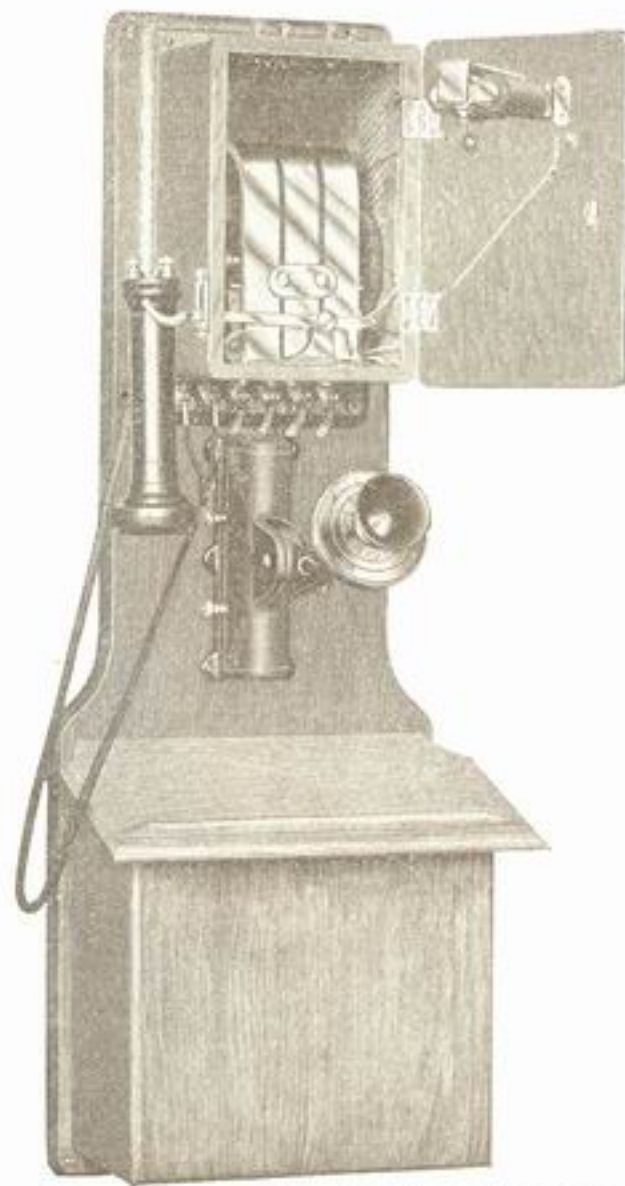

No. 6A AND 7A TELEPHONE

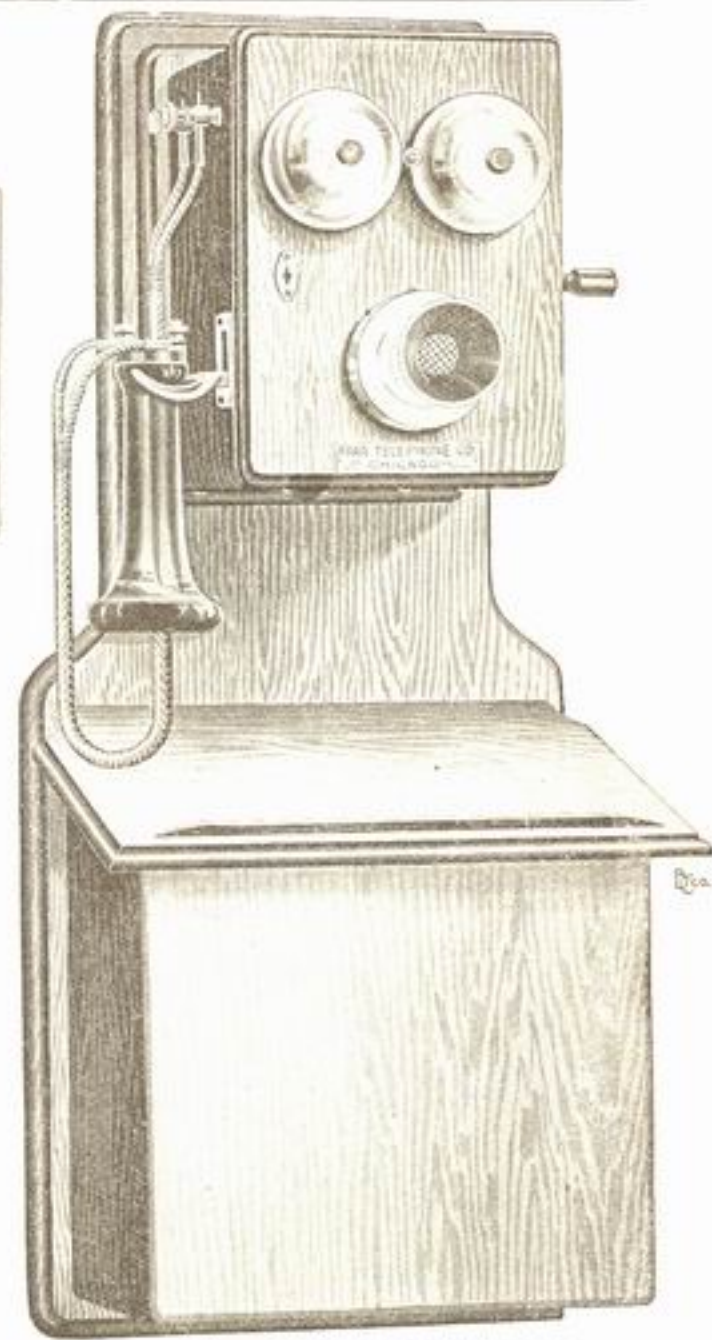

No. 8 TELEPHONE

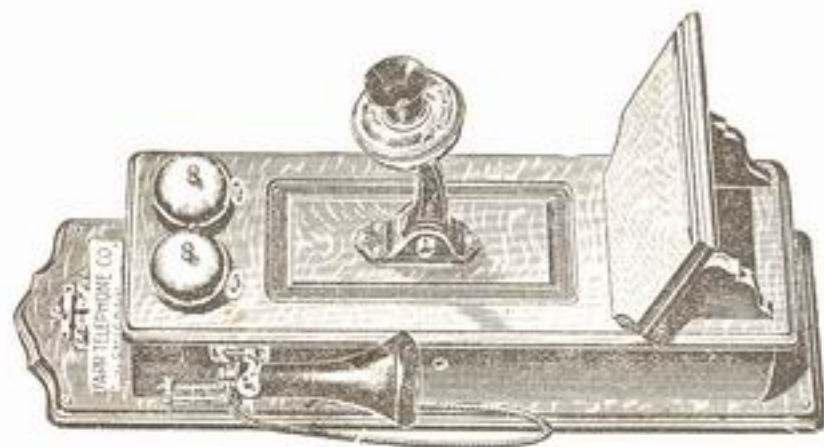

TELEPHONE No. 14—Closed.

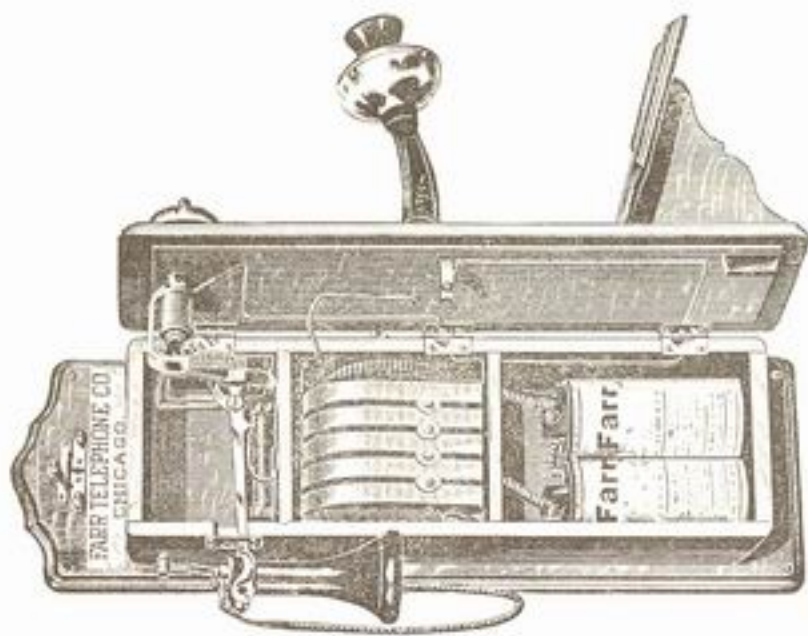

TELEPHONE NO. 14—OPENED.

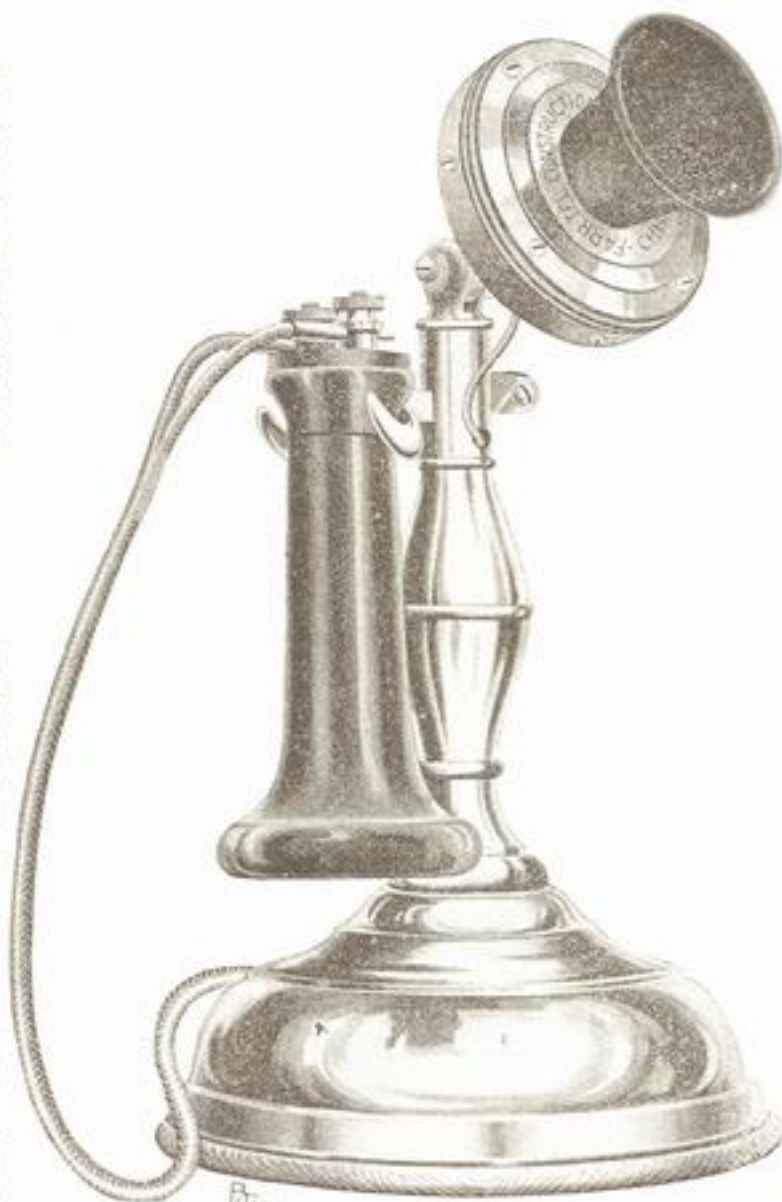

No. 10 DESK TELEPHONE

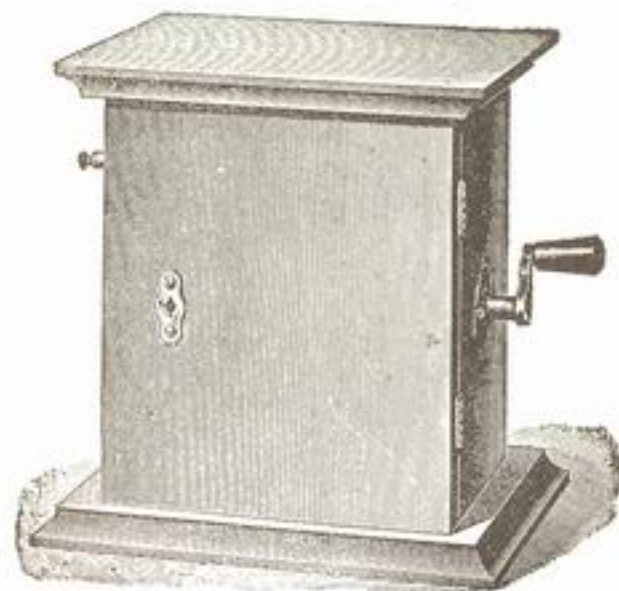
SIGNAL BELL
FOR DESK TELEPHONEGENERATOR
FOR DESK TELEPHONE

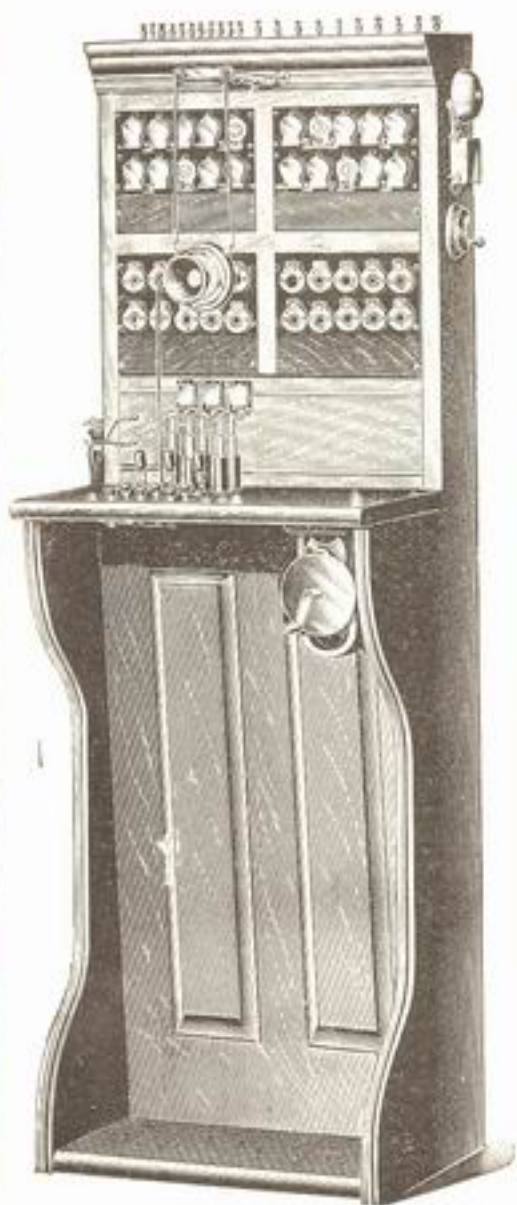

No. 1 SWITCH BOARD
Capacity 30 Drops, with 20
Drops and Jacks Mounted

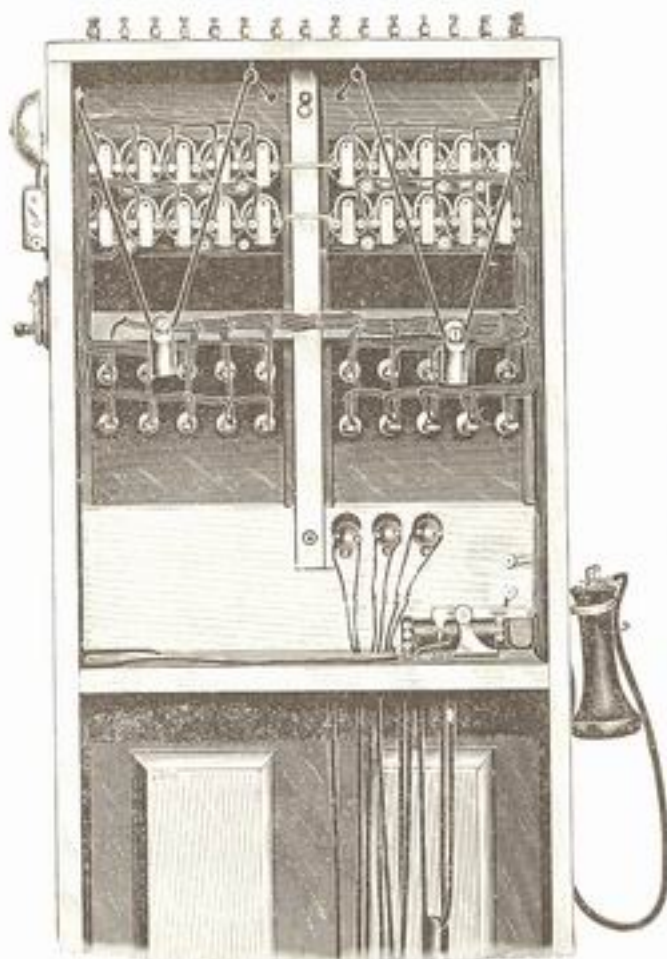

No. 1 SWITCH BOARD
Back View.

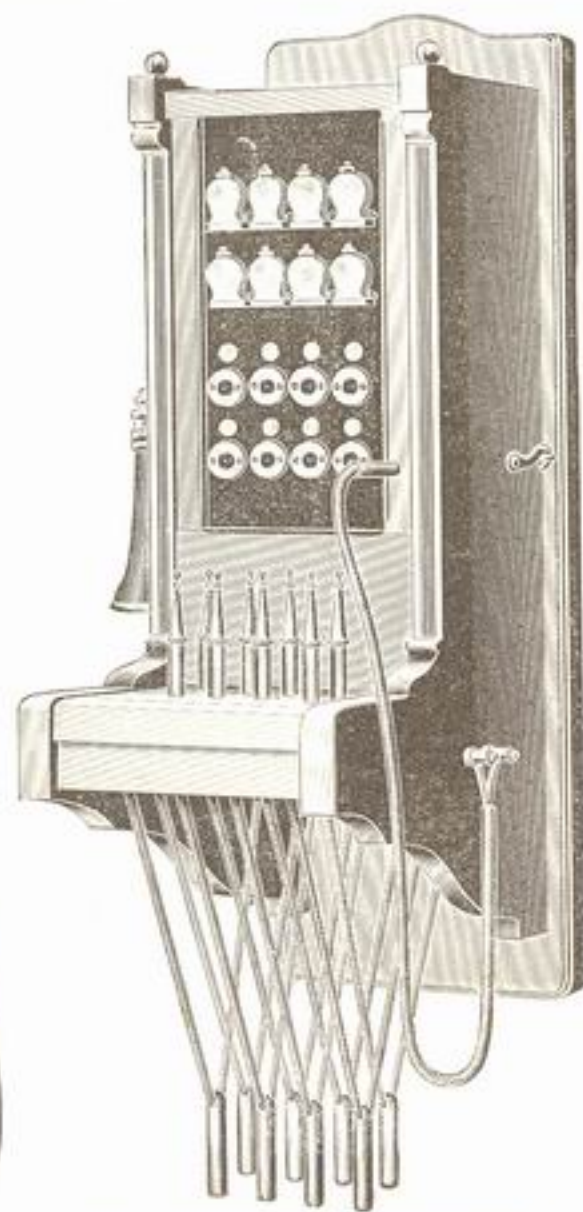

No. 3 SWITCH BOARD
For Series Lines or
Bridging Lines.

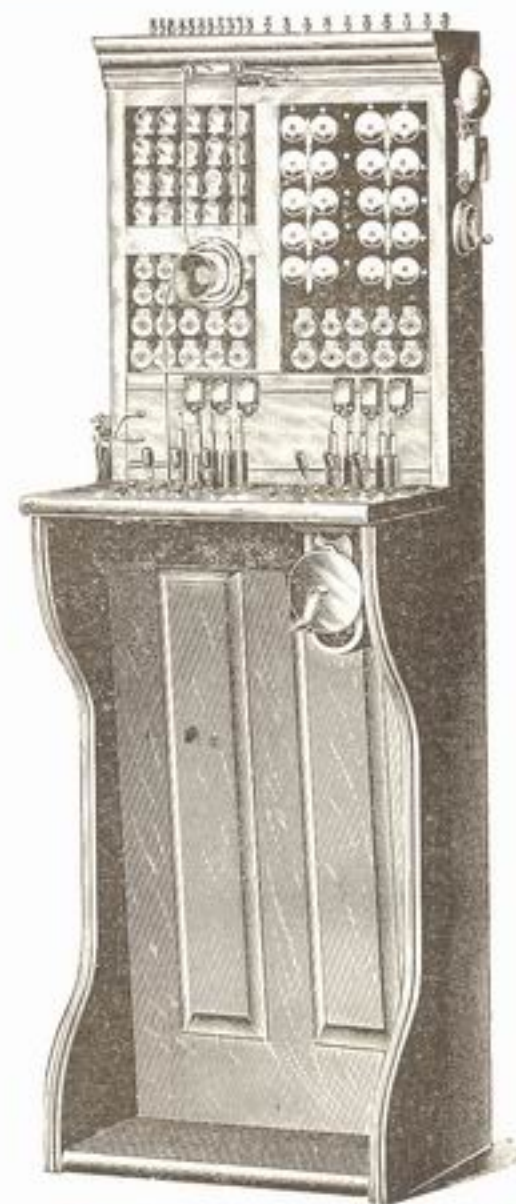

No. 2 SWITCH BOARD
20 Drops for Series Exchange Lines and 10
Gongs and Jacks for Bridge Lines

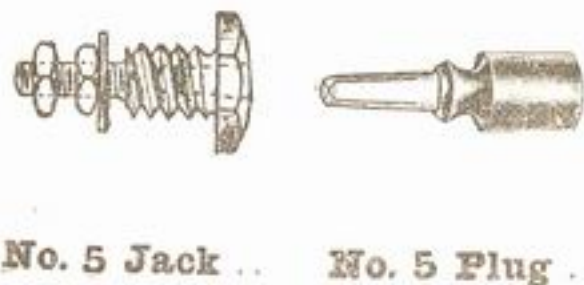
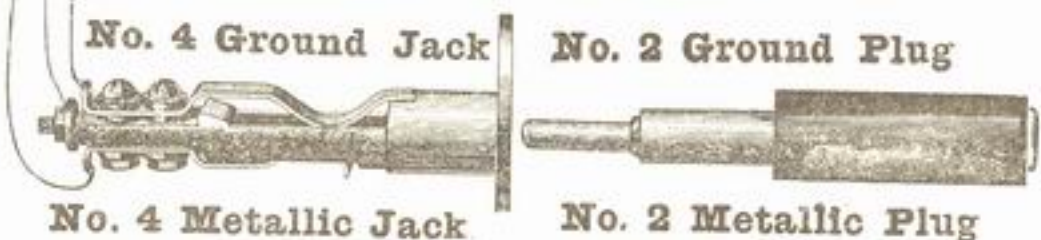
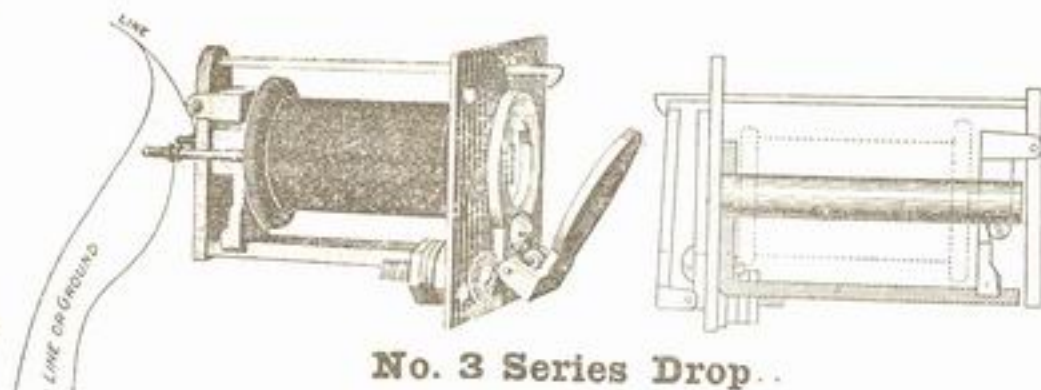
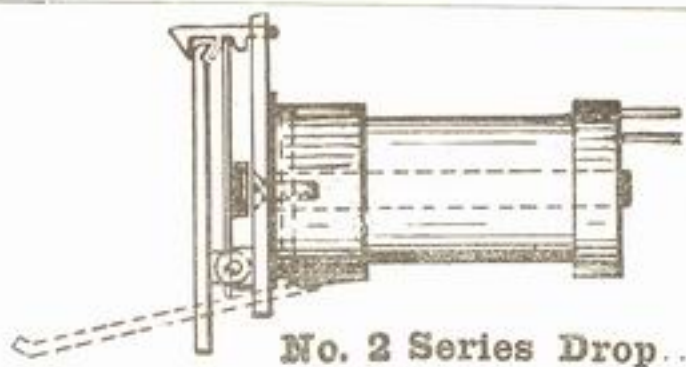
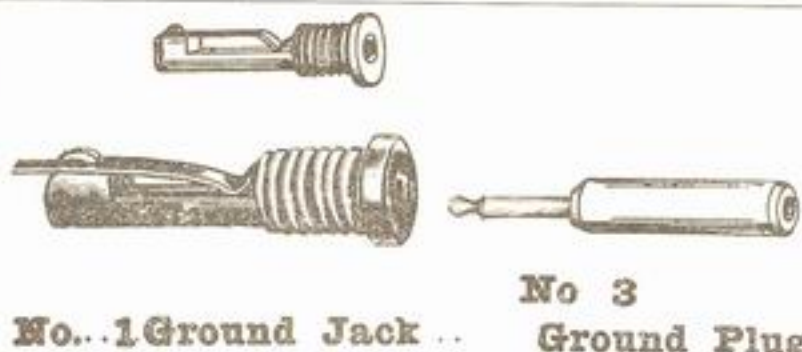
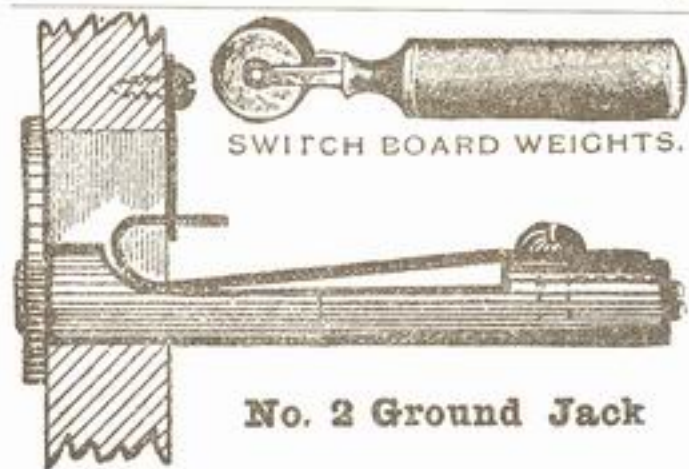

Extension Bells

Price 100 Ohm - - - \$3.50
 Price 500 Ohm - - - 5.00
 Price 1,000 Ohm - - - 6.00

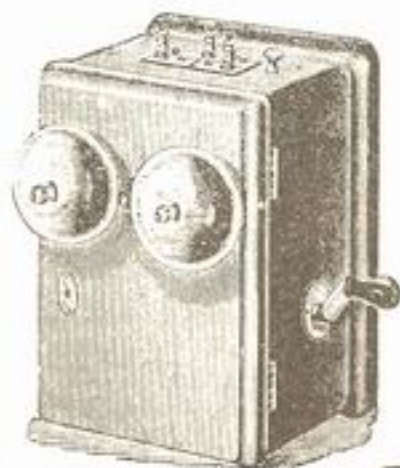

Magneto and Extension Bell

Boxes with Lock and Hinges.

Bell Boxes, Price - - - \$1.00
 Extension Bell Boxes, Price, 80c

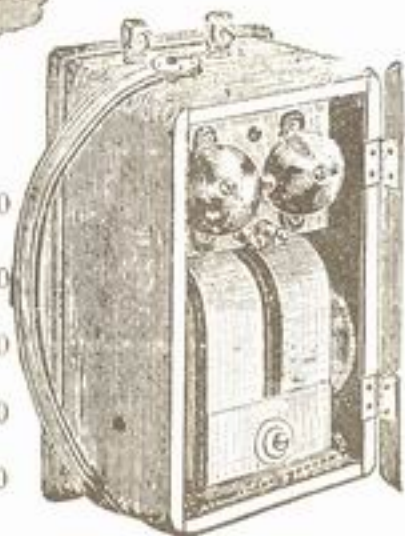

Testing Bells
 For Linemen

Price 10,000 Ohm - - - \$ 8.00
 Price 15,000 Ohm - - - 8.50
 Price 20,000 Ohm - - - 9.00
 Price 25,000 Ohm - - - 10.00
 Price 50,000 Ohm - - - 16.00

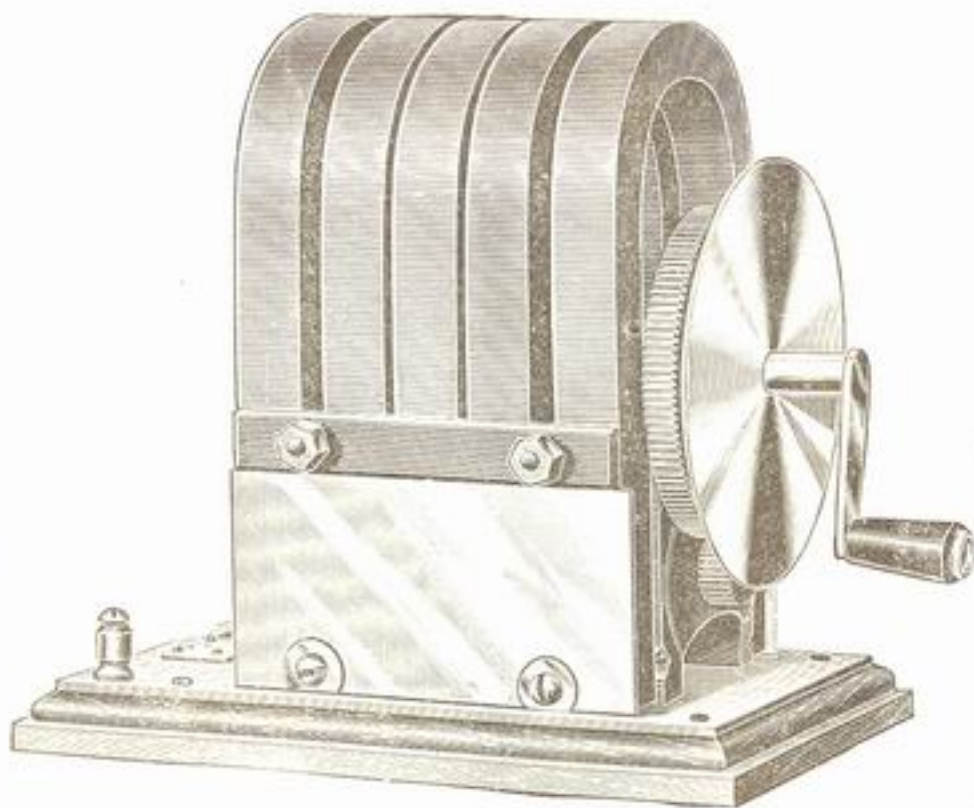

No. 4 SWITCHBOARD GENERATOR.
 For Series or Bridging Lines, 50,000 Ohms.

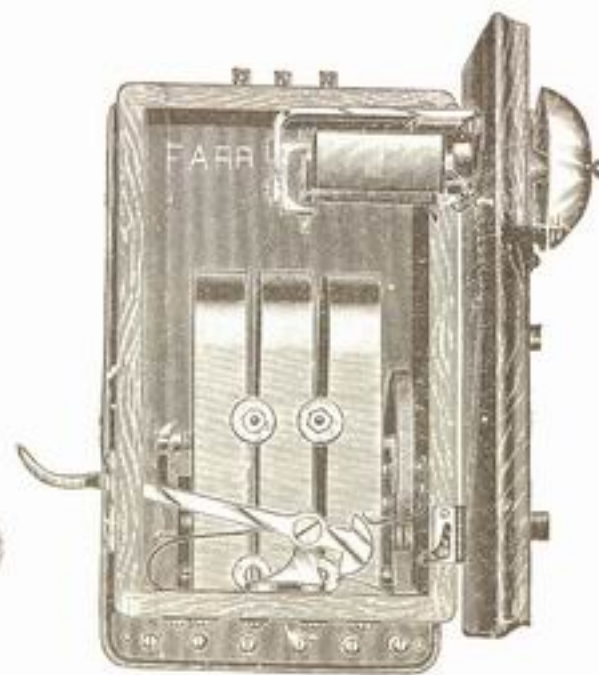

No. 2 Bridging Magneto Bell

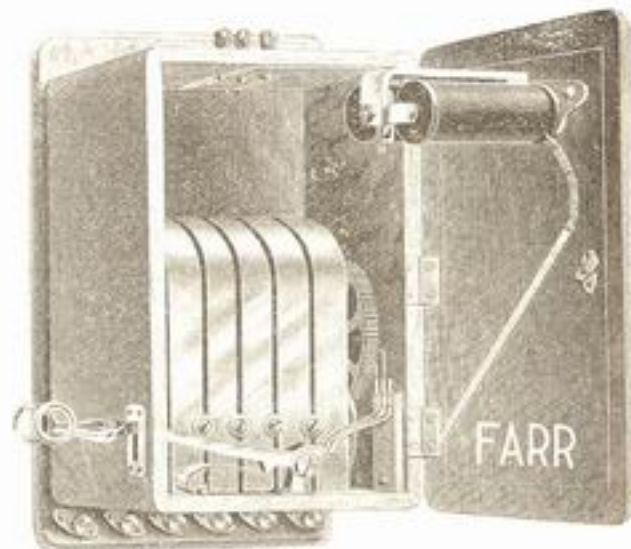

MAGNETO BELL No. 6.
 Bridging or Series, 50,000, 75,000, 100,000 ohms.

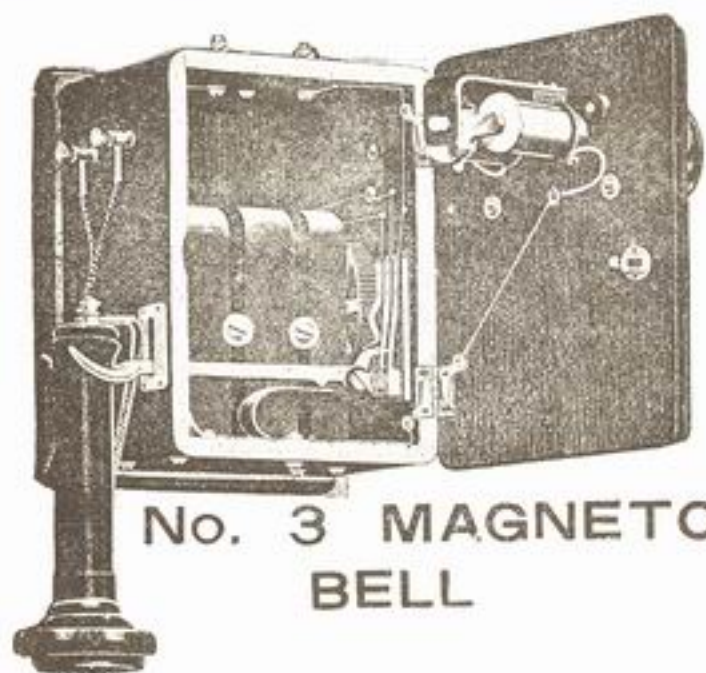

No. 3 MAGNETO
BELL

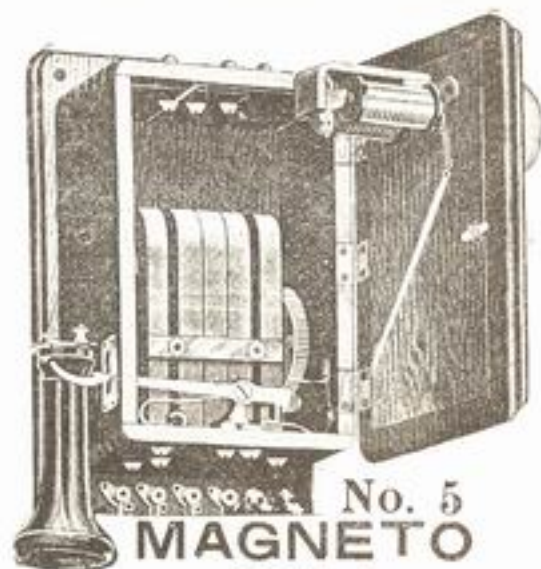

No. 5
MAGNETO
BELL



No. 1 MAGNETO
BELL

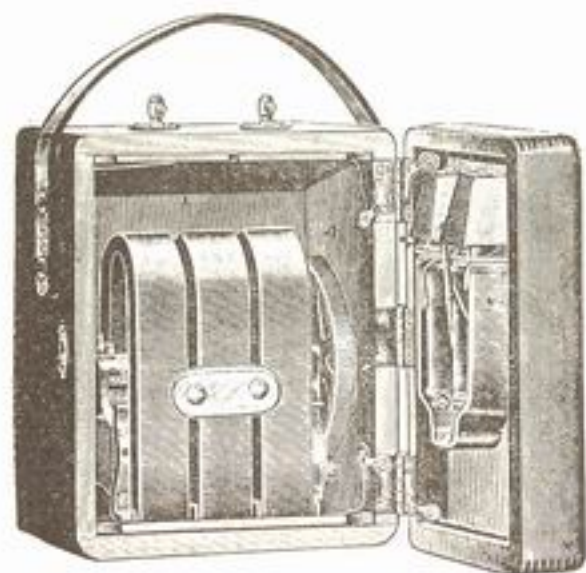

TESTING BELL.



EXTENSION BELLS.

FANCY CONGS.



EXTENSION BELLS.



LINEMANS TEST SET

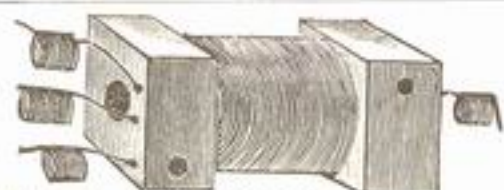

No. 1 INDUCTION COIL.



Stationary Hook.

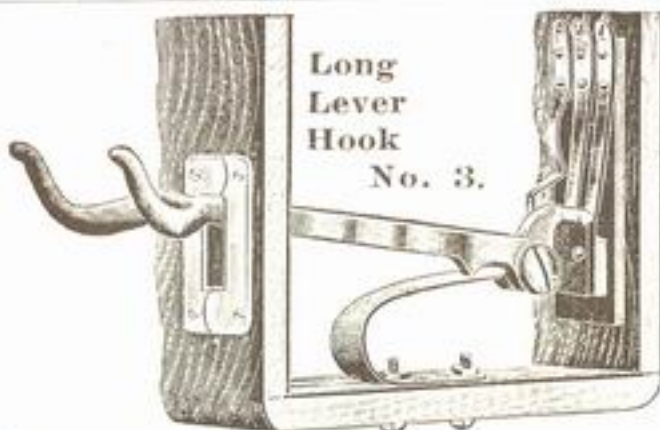

Long Lever Hook No. 3.



Eureka Hook No. 2.

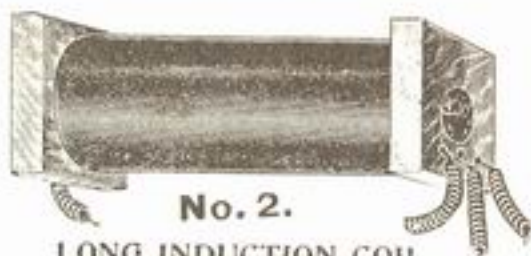

No. 2. LONG INDUCTION COIL.



No. 4.

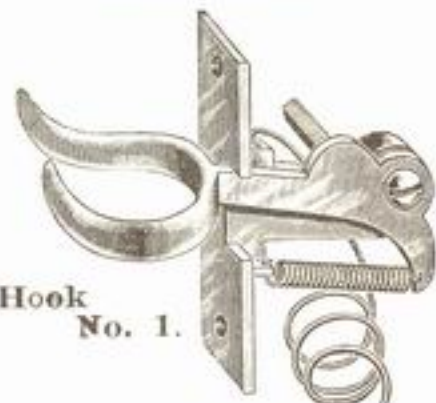

Hook No. 1.



Extension Bell. Buzzer.



Box Coil.

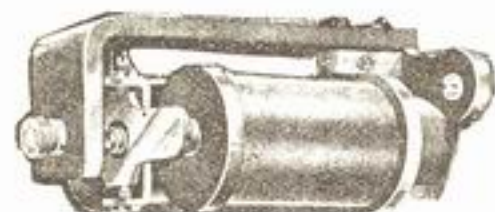

Ringer Coils

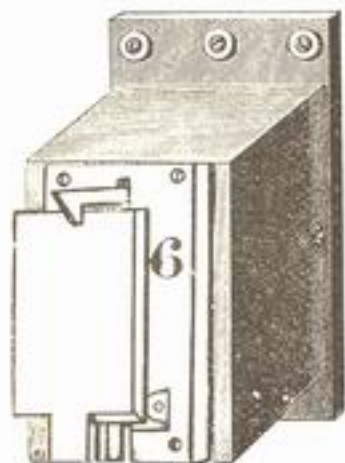

Magneto Drops.

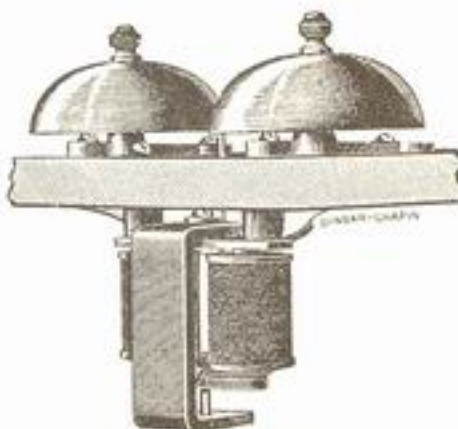

Ring Coils and Gongs.



Battery Drops.

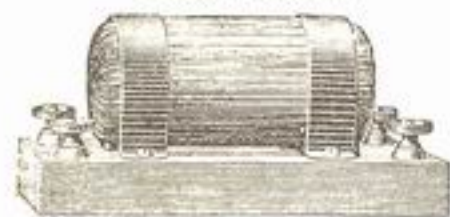

REPEATING COIL. (IMPORTED)

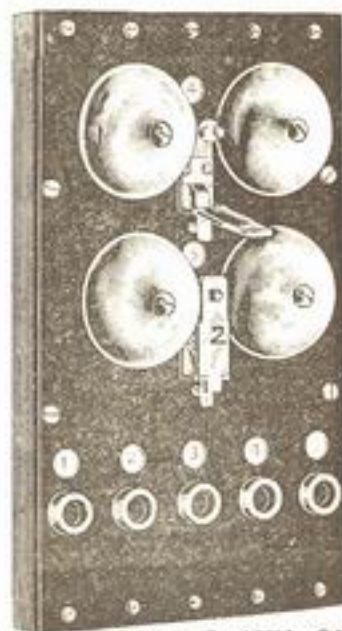

BELL PANEL OF SWITCHBOARD



Double Pole
Watch Case Receiver



Double Pole.
HEAD RECEIVER.
No. 2,

RECEIVER



KEELYN.
Receiver.



Double Pole
Head Receiver.
No. 1



Watch
Case
Single Pole.

Receiver.



Receiver
Cords

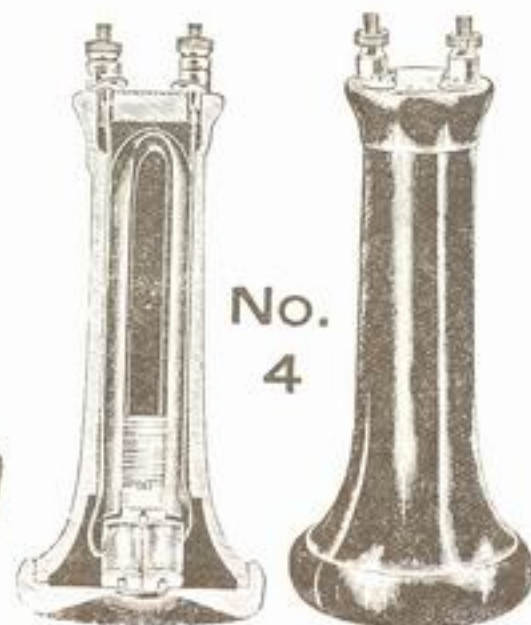

No.
4

Double Pole Receiver.



RECEIVER SHELLS.



WATCH CASE
Pony Receiver.



Single Pole

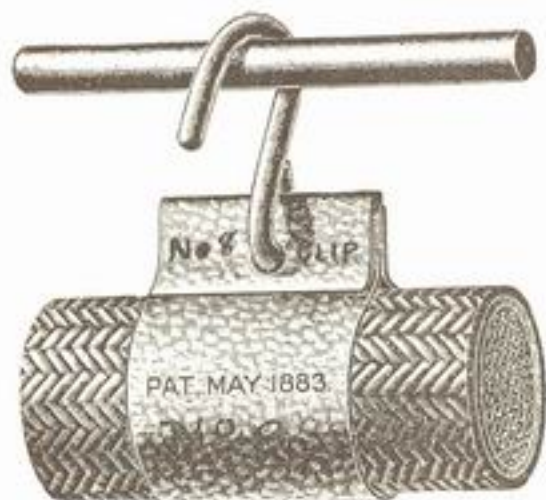

Boston Cable Clip.



No. 523.



No. 522.

Long Distance Telephone Mouthpiece,



Cap for No. 5191/2 Receiver Case.



Express.
WATCH-CASE TELEPHONE RECEIVER.



TANDEM 44 INCH
TWO CELL LONG NARROW STYLE

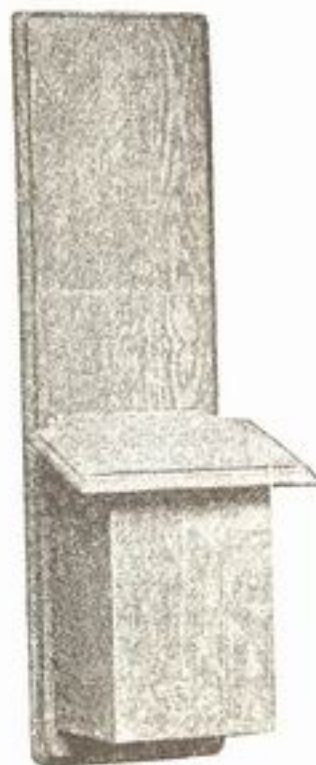

26 INCH



32 INCH
THREE CELL STYLE



31 INCH
ONE CELL STYLE



Disc, No. 1



Disc, No. 3.



Disc No. 2.



Carbon Diaph.



Granular
Carbon



Transmitter,
Box with mouth piece.



Blake
Box



Combined Transmitter
and Receiver.

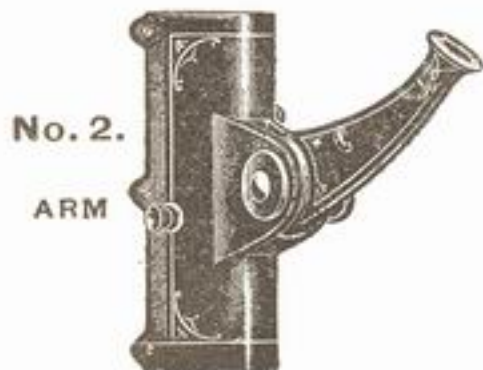

No. 2.
ARM

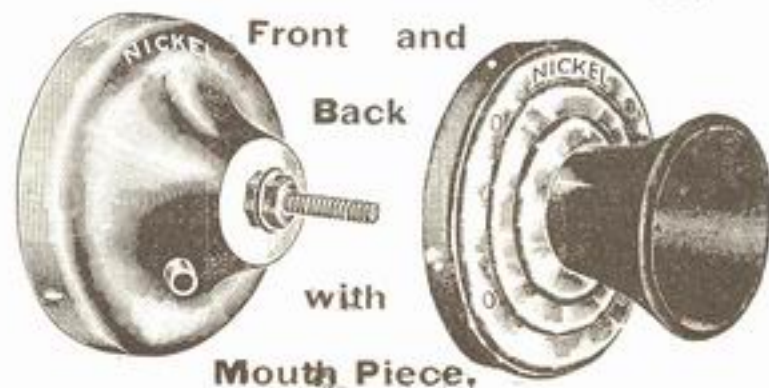

Front and
Back
with
Mouth Piece.

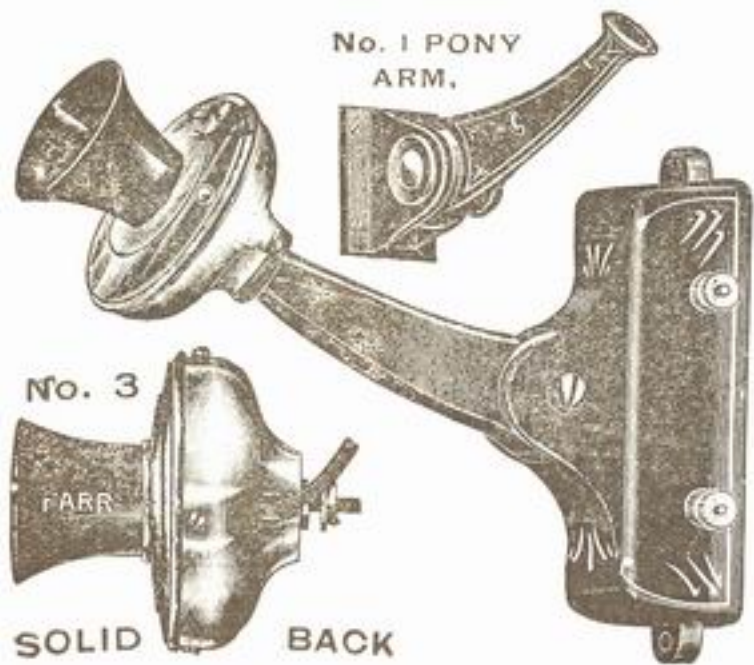

No. 1 PONY
ARM.

No. 3

SOLID
BACK

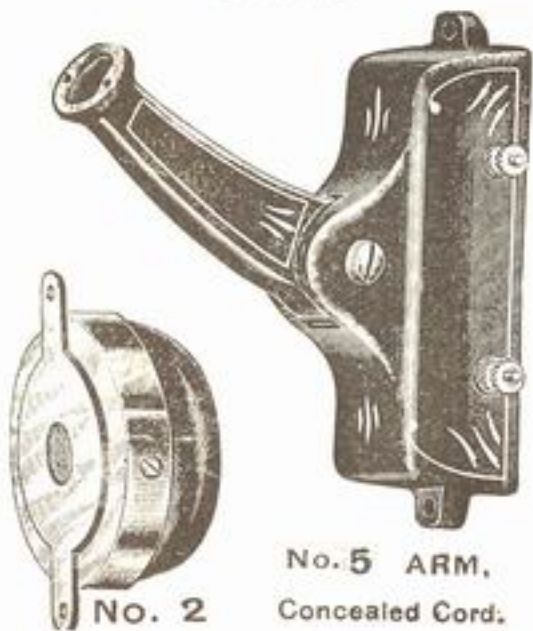

No. 5 ARM,
Concealed Cord.



No. 2

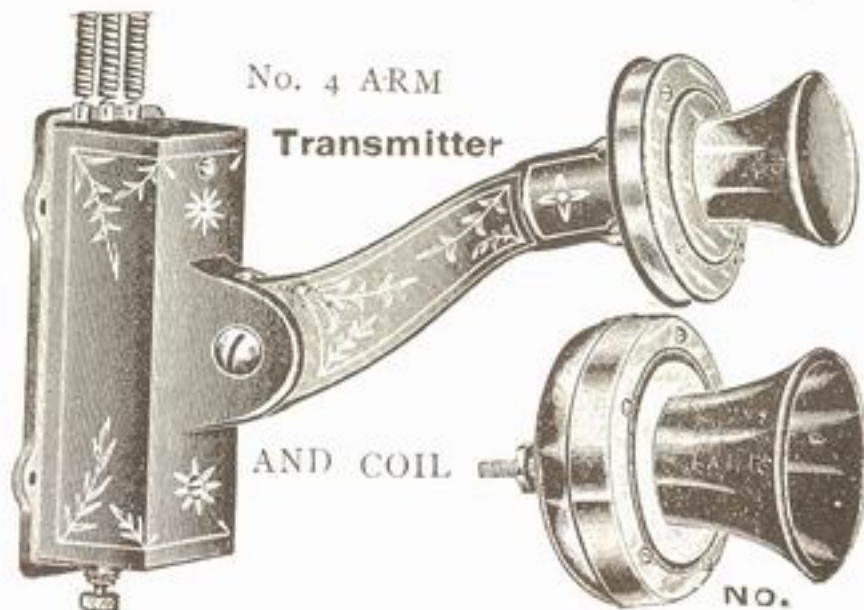

No. 4 ARM
Transmitter

AND COIL

NO.

POLE-TOP CABLE TERMINAL.



FUSED TERMINAL AND DISTRIBUTING BOX.

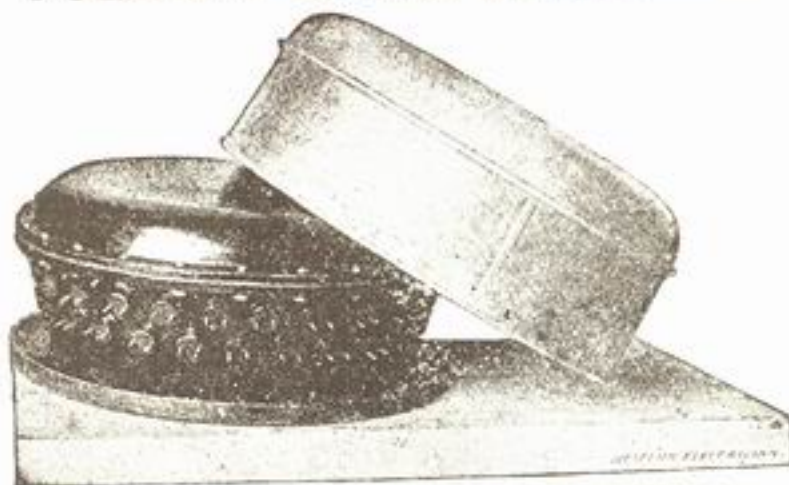

Telephone Protective Devices—View of Pole-top Terminal, Cover Removed.

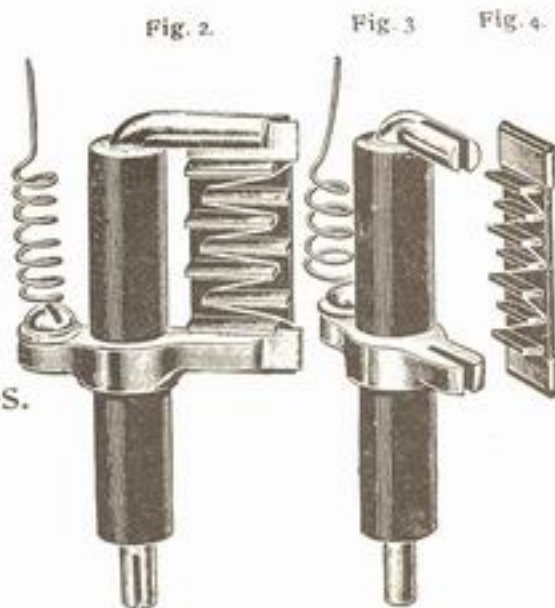

Fuses for Fused Cable Box.

Copper Fuse Wire Terminals.

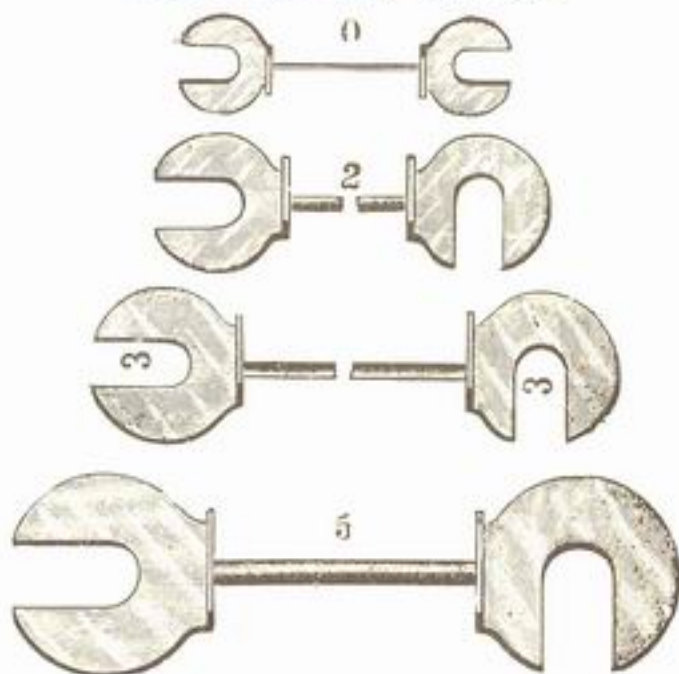

Terminals are shown full size.

			Price.
15 Ampere,	No. 0	1 inch	per hundred, \$2.00
15 "	"	2 1/2 "	" " " 2.00
100 "	"	3 1/2 "	" " " 3.00

Above are Edison style

15 Ampere,	No 2	2 1/2 inch	per hundred, \$4.00
25 "	"	3 2 1/2 "	" " " 4.00
100 "	"	5 2 1/2 "	" " " 5.00

Above are S-M. style

STAMPED FUSE LINKS.



Combined Carbon and Fuse Lightning Arrestor.

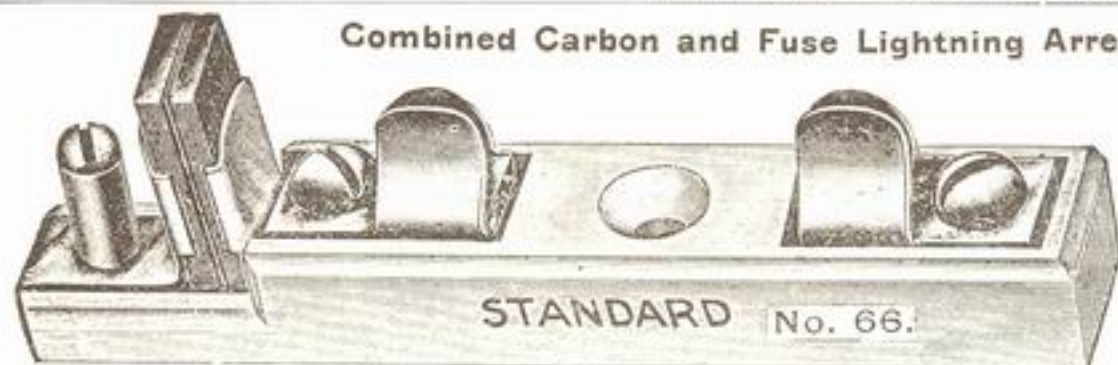

Western Union Style Block.

Telephone Fuse Block and Fuses.

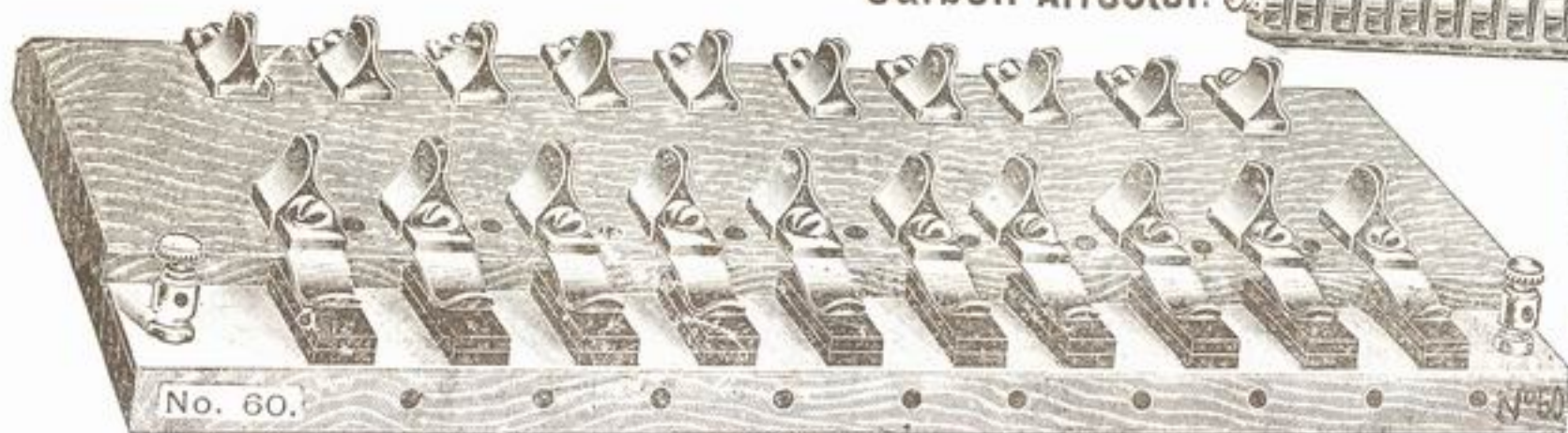
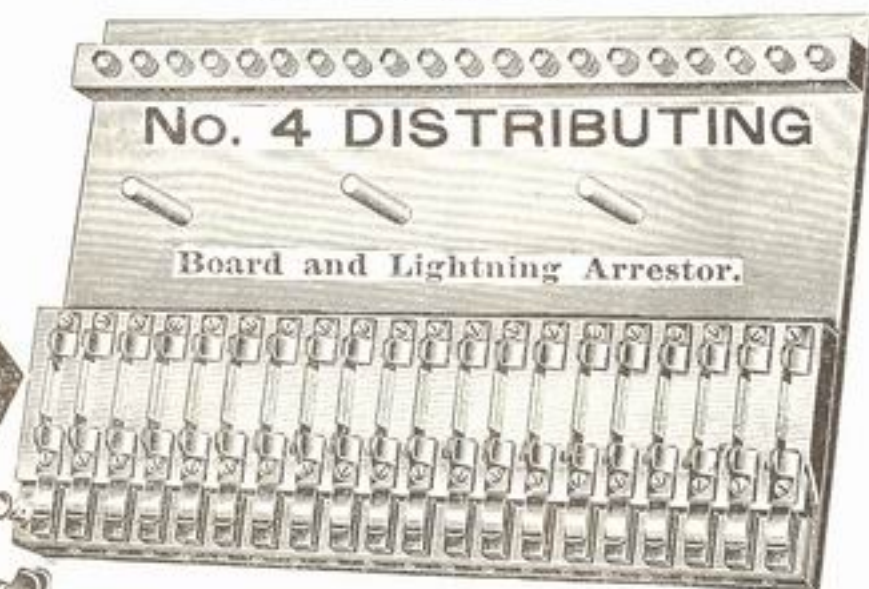
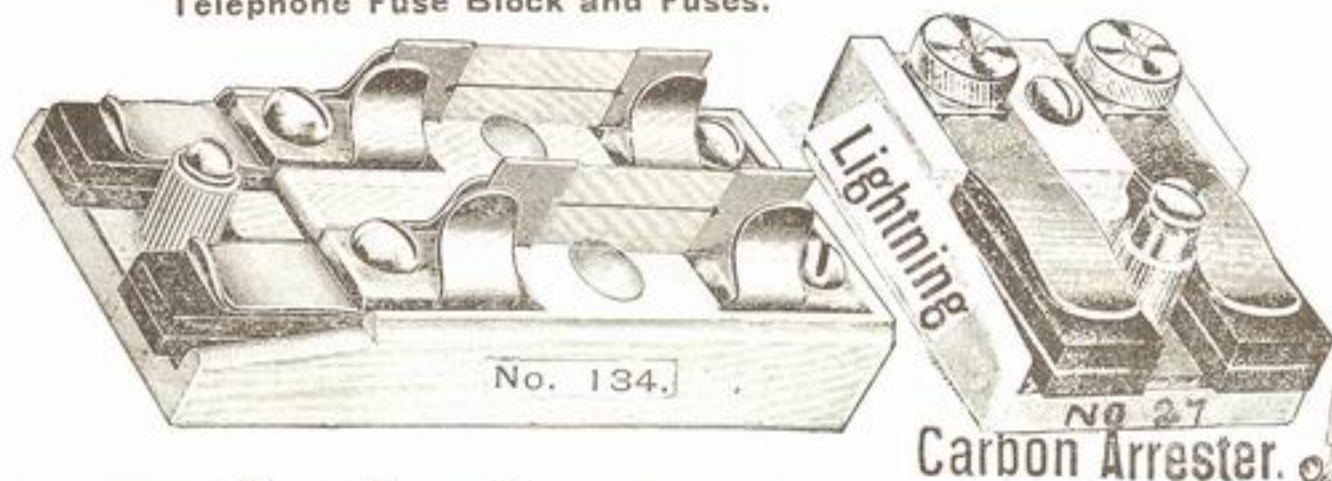

CARBON LIGHTNING ARRESTER



W. U. Fuse 1/2 ampere,

Postal Fuse 1/2 ampere,





No. 7.—Collar Signal Zinc, plain.



No. 1.—5 x 7 Crow Foot Zinc.



No. 2.—Fuller Zinc, plain.

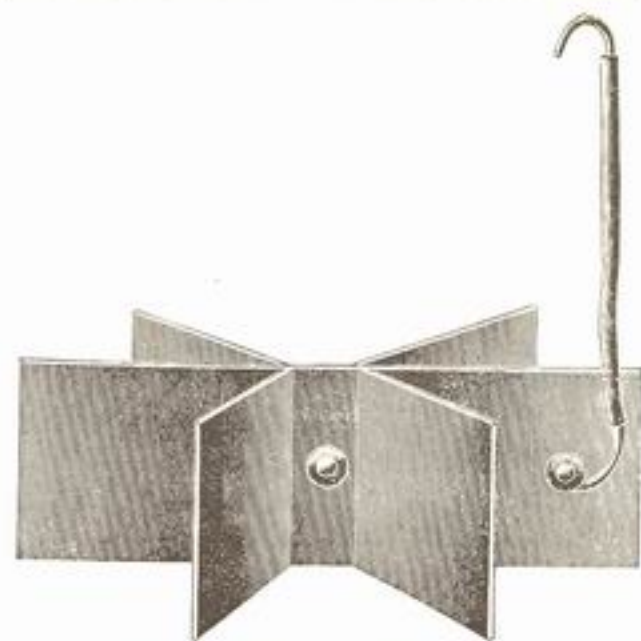

No. 5.—6 x 8 Battery Copper, each



No. 10.—Round Rod Le Clanche Zinc.



No. 11.—Square Le Clanche Zinc, each



National No 2 Cell.



CYLINDER.

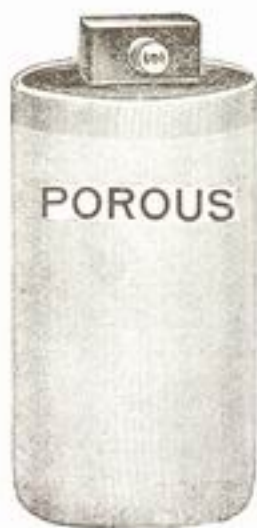

Porous Cups.



AMERICAN STORAGE BATTERIES.
FIG. 8.



FIG. 7. Cautery Style.



Edison-LaLande Battery.



Hydrometer.
For testing Gravity and
Storage Batteries.



Warner Patent Electric Gauge.
POCKET Battery Tester



Battery Syringe.



Battery Brush.



Hand Dynamo



ELECTRIC CALL BELL OUTFIT.



Battery Knife.



Battery Cases for Physicians, Dentists.

Furnished With and Without Batteries.

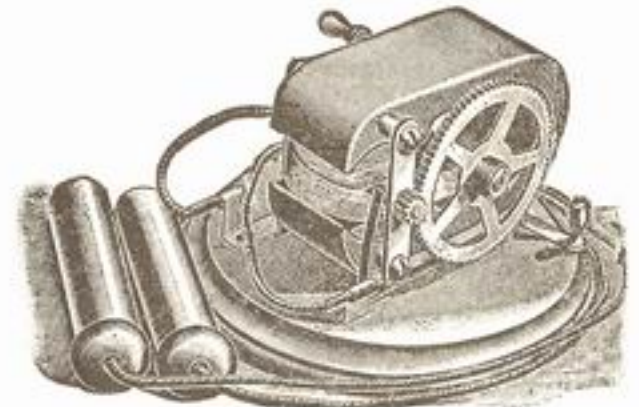

MAGNETO MEDICAL BATTERY.

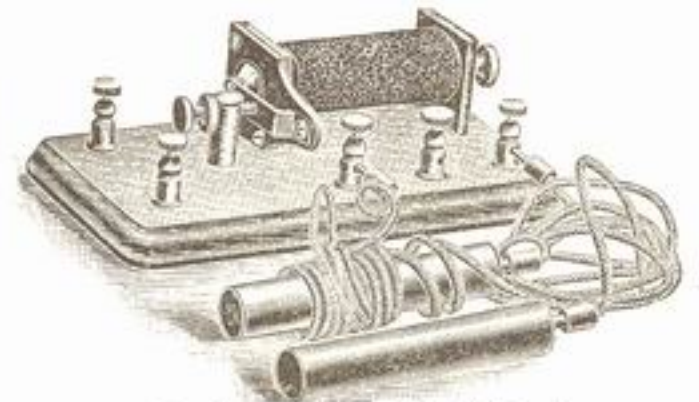

Medical Battery No. 1



Cow Bell Gong.



SWISS (3 inch).



OPEN BELL (3 1/4 inch).



Dinner Gong



Sleigh Bell Gong.



Iron Box Bells.



No. 5076.



No. 5077.



No. 5078



No. 5074.



No. 5075.



No. 5098



No. 9358.

FANCY CAST GONGS.



Iron-Box Buzzer.



Watch-Case Buzzer.



Iron Monitor Bell.



Skeleton. Bell



WOOD Box Bell,



Key and Sounder No. 1.



Key and Sounder No. 2.



Legless Steel Lever Key.

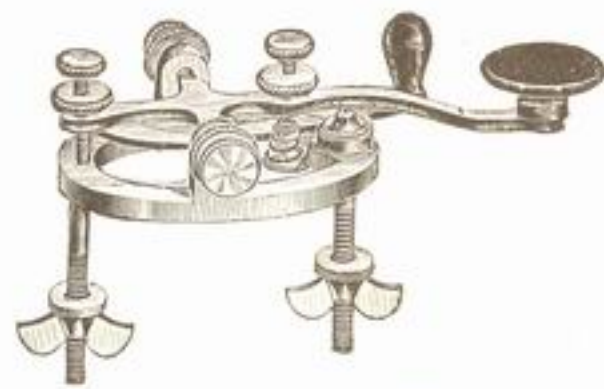

Steel Lever Key.

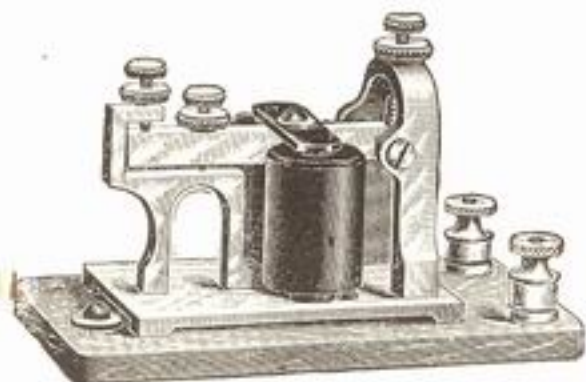

Improved Giant Sounder.

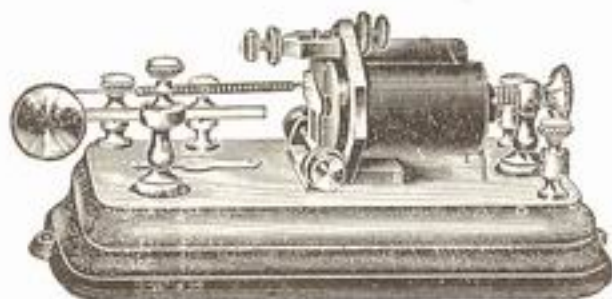

W. U. Standard Relay.



Key and Sounder No. 3.

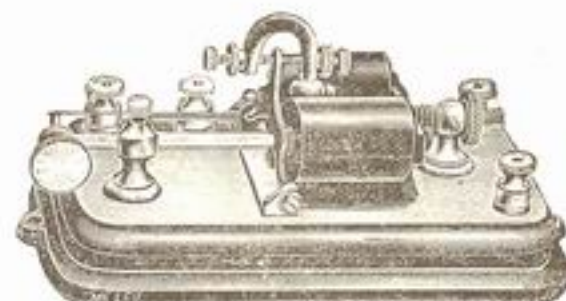

Main Line Relay.



Giant Combination Set.

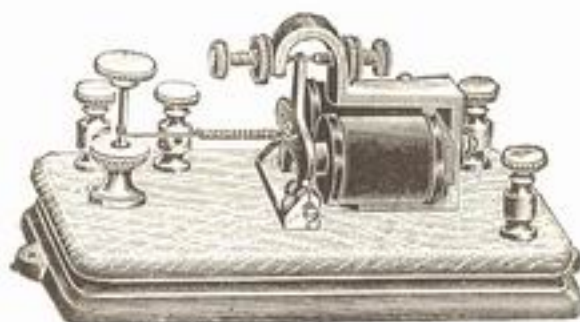

Standard Pony Relay.



Key and Sounder No. 4.



Key and Sounder No. 5.

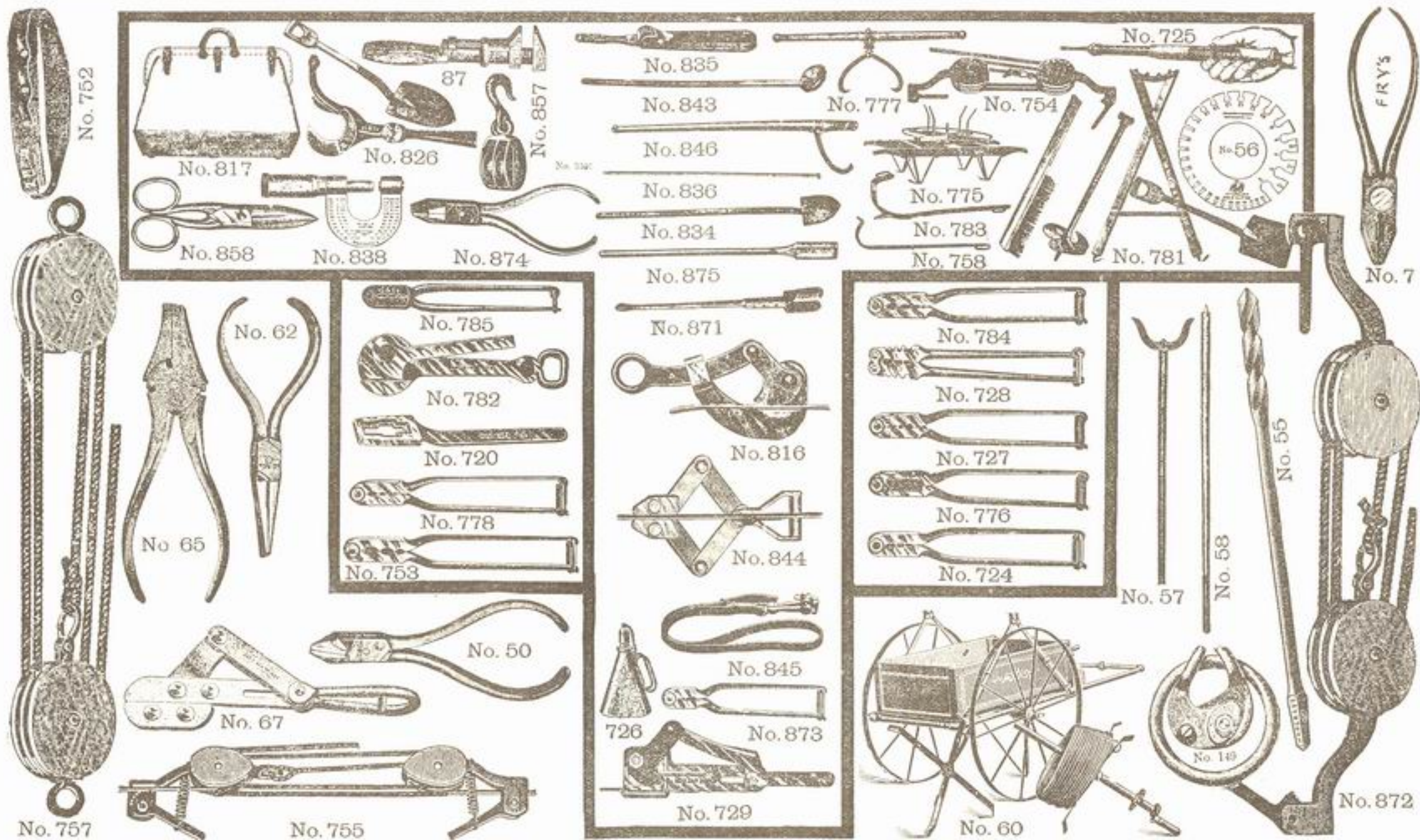



Glass Insulators
 Pony,
 Price each, 4 cts.
 or
 \$28.00 a thousand

Porcelain Knobs

For use on Building or
 Cross Arms.

Price, No. 4, each 2c, or
 \$16.00 per thousand.



BRACKETS, OAK.
 Price, each 4c, or \$26.00 per thousand.



Pins Oak
 Price, each 2c, or \$14.00 per thousand.



Cross Arms
 Price: Each, 4 pins, 40c; 6 pins, 60c; 8 pins, 80c; 10 pins, \$1.20. Write for quantity price.

Insulators—Glass—



REGULAR NO. 3 INSULATOR.

From Chicago stock Price,
 in 1000 lots, \$50.00



DEEP GROOVE PATTERN.

From Chicago stock Price,
 in 1000 lots, \$55.00



W. U. DOUBLE PETTICOAT

Chicago stock in 1000 lots, \$70.00
 factory in 1000 lots, 65.00



Insulators—
DOUBLE GROOVE PONY INSULATOR.

Price.
 From Chicago stock in 1,000 lots, \$30.00

'PONY' GLASS INSULATOR.

Price.
 From Chicago stock, 1,000 lots, \$26.00
 " " bbl. lots, 28.00



DEEP GROOVE, DOUBLE PETTICOAT, PONY.

telephone and light electric light wiring.

Price,
 From Chicago stock 1,000 lots, \$45.00

BROWN'S DUPLEX GLASS INSULATORS



Price.
 Chicago stock, deep groove each \$0.09
 " " pony each 18



ELECTRIC SOLDERING IRONS.



No. 10. Weight, 16 oz., length of iron, 11 ins., tip, $\frac{3}{8}$ in. in diameter, pointed. Consumes 100 watts.



No. 11. Weight, 15 oz., length of iron, 12 ins., tip, $\frac{7}{16}$ in. in diameter. Consumes 90 watts.



No. 20. Weight, 1 lb. 10 oz., length of iron, 13 $\frac{1}{2}$ ins., tip, 1 in. in diameter. Either pointed or chisel shape. Consumes 155 watts.



No. 21. Weight 1 lb. 6 oz., length of iron, 13 ins., tip, $\frac{9}{16}$ in. in diameter. Consumes 155 watts.



No. 30. Weight 2 lbs. 8 oz., length of iron, 14 ins., tip, 1 $\frac{1}{8}$ in. in diameter. Either pointed or chisel shape. Consumes 300 watts.



No. 31. Weight 1 lb. 14 ozs., length of iron, 14 ins., tip, 1 $\frac{1}{16}$ in. in diameter. Consumes 250 watts.



No. 32. Weight 1 lb. 17 oz., length of iron, 15 $\frac{1}{2}$ ins., tip, 1 in. in diameter. Either pointed or chisel shape. Consumes 280 watts.



No. 40. Weight 4 lbs. 4 oz., length, 15 inches, tip 1 $\frac{1}{2}$ ins. Either pointed or chisel shape. Consumes 475 watts.

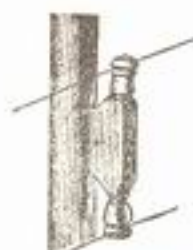

Brackets.

Brown duplex, painted

From Chicago stock... per 1,000, \$50.00

Price,



Extra heavy oak, painted.

From Chicago stock... per 1,000, \$21.00

Price,

" factory... " 20.00

Pole Steps.



Price,
Diameter $\frac{3}{8}$ inch, length 12 $\frac{1}{2}$ inches, plain... per 100, \$4.00
" $\frac{3}{8}$ " " 9 $\frac{1}{2}$ " galvanized " 100, 5.00

Lag Screws.



No. 3378

2x4 Lag Screw, per 100.
3x4 " " " "
5x4 " " " "
7x4 " " " "
7x4 " " " "

Painted Cross Arms.



Above Arms of best Michigan white pine. Special prices.

Pins.



No. 2052.

No. 3154.



No. 2671.

No. 3394.

2052	Standard, 1 $\frac{1}{4}$ inch, Painted Oak Pin, per 1,000.	18.00
	In crates of 500.	
2053	Standard, 1 $\frac{1}{4}$ inch, Painted Oak Pin, per 1,000.	18.00
	In crates of 500.	
2054	1 $\frac{1}{4}$ inch Locust Pin, not painted, per 1,000.	30.00
	In crates of 500.	
2055	1 $\frac{1}{4}$ inch Locust Pin, not painted, per 1,000.	30.00
	In crates of 500.	
2671	Brown Duplex Pin, 1 $\frac{1}{4}$ inch, Oak, per 1,000.	25.00
2672	" " " 1 $\frac{1}{4}$ " Locust, " "	35.00
3154	Corner Pin, 1 $\frac{1}{4}$ inch, Oak, each.	.07
3155	" " " 1 $\frac{1}{4}$ " Locust " "	.10
3394	1 $\frac{1}{4}$ inch Solid Iron Pin, each.	.20

WESTERN UNION STANDARD STEEL CROSS ARM PIN.



Price,
 $\frac{1}{8}$ in. shank, complete with hardwood thimble, nut and washer, per 1000... each, \$0.08
Per 100... " .10



No. 233.

Insulators—Glass

**No. 1, Glass
Insulating or Break Knob.**

1 1/4 inches long, 1 1/4 inches wide, 1/2 inch hole.

233: Per 1,000..... 20.00

No. 2. Glass Insulating or Break Knob.



No. 233.

1 1/4 inches long, 2 inches wide, 1/2 inch hole.

233: Per 1,000..... 30.00

No. 3, Glass Insulating or Break Knob.



No. 233.

2 1/4 inches long, 2 inches wide, 1/2 inch hole.

233: Per 1,000..... 40.00

insulators—Porcelain

No. 0.



Price.
Per 1000 \$130.00
" 100..... 15.00

No. 1.



Price.
Per 1000..... \$90.00
" 100..... 10.00

No. 2.



Price.
Per 1000..... \$36.00
" 100..... 4.50



No. 3540. 3540 4x 1/2 Standard Carriage Bolt, per 100.



Wood Poles.



P. & S. Circuit Breaker.



Carriage Bolts.



Turn Buckles.



Guy Clamps.



Pole Steps.



NO. 1
Table Clamp Push
Price.....\$1.00

No. 6 Push Button
Price 70c



Receiver Binding Post.
Price, each 6 Cts.

RECEIVER BOBBIN.
Wound with Silk Wire, 75 Ohms
Price 20 Cts



NO. 2
Push Button
Light Bronze
Price 50c
Price, plain..... 30c



No. 7 Push Button
Light Bronze
Price 70c



Thumb Screw, Nickel, Price 10c.
Brass, Wood Screw. Price 12c.
Lock Nut, Price 15c.

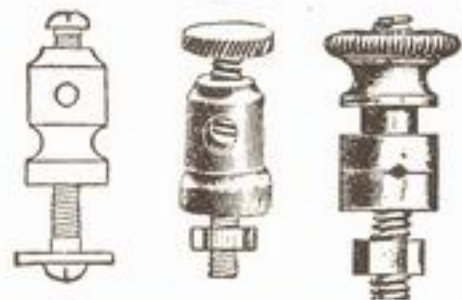

NO. 3
Compound Push Button
2 push, price.....\$.70
3 push, price 1.00



No. 8 Push Button
Oak, Walnut or Ash
Price 20c



NO. 4
Bell and button Combination
Wood or Metal
Price \$3.00



No. 9 Desk Push
Rubber Center, Nickel Plated
Price 40c



Thermostat
To protect your buildings and notify you when the heat in ady room where the Thermostat is placed becomes 100 degrees.

NO. 5
Push Button
Light Bronze
Price 75c



Movable Floor Push
Nickel
Price, complete with Cord..... \$2.00



BINDING POSTS.

Burglar Alarm Attachments.



Door Spring

Price..... 35 cents.

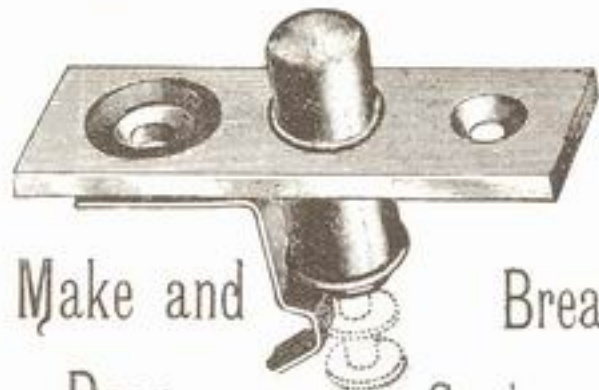

Make and Break Door Spring.

For use on store doors, etc.

Contact is made as the door opens and as it shuts, but not while it is open or shut.

Price..... 24 cents.

BURGLAR ALARMS.



Window Spring.

Price..... 22c



Double Window Spring.

Price..... 40c.



Yale Lock.
Burglar Alarm Switch.

These switches are placed on the doors of stores, residences and other buildings connected with burglar alarm systems, so that persons having the proper keys can go in or out of the building without ringing the alarm.

Price..... \$1.50



Electric Floor Matting.

Price per square foot..... 60c

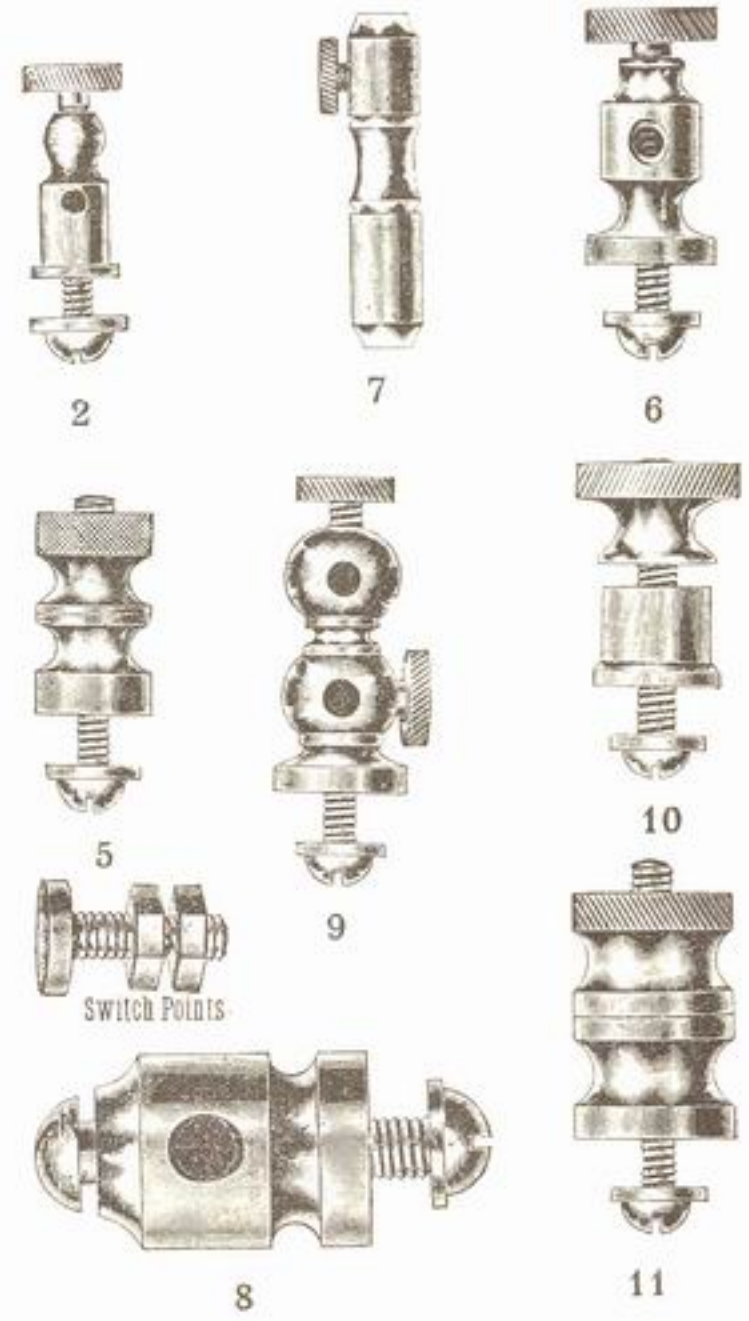

2

7

6

5

9

10

SWITCH POINTS

8

11



Annunciator Wire

Price, No. 16, 60c
 Price, No. 18, 64c
 Price, No. 20, 68c

Office Wire

Price, No. 16, 62c
 Price, No. 18, 64c
 Price, No. 20, 66c



Magnet Wire

Price, 40 per cent. off the list.



Galvanized B B Iron Telephone Wire

Price, No. 9 per lb. 8c
 Price, No. 14 per lb. 10c
 Price, No. 12 per lb. 8c

Hand Drawn Copper Wire

Price on Application.

Galvanized Fence Wire

Price, No. 12 and 14, 7c lb.



Magnet Wire

No. 31—S.	Covered Cotton	180 lb.
No. 32—S.	" "	195 lb.
No. 33—S.	" "	240 lb.
No. 34—S.	" "	285 lb.
No. 36—S.	" "	437 lb.



No. 31—S.	Covered Silk	325 lb.
No. 32—S.	" "	345 lb.
No. 33—S.	" "	390 lb.
No. 36—S.	" "	700 lb.



Wire Gauge

American Standard Wire Gauge

Price \$5.00

Wire and Electro Magnet Winder

Price \$8.00



BANNER WEATHER-PROOF WIRE.

Prices on application.



UNDERWRITERS' LINE WIRE.

Prices on application.

White in Color.

HARD-DRAWN COPPER WIRE

With Weather-proof Insulation.

No. 10, B & S Gauge	} Prices on application
No. 12, " "	
No. 14, " "	

BARE COPPER WIRE.



These cuts represent exact sizes.

MAGNET WIRES.



Special prices on

application.

GAS FIXTURE WIRE,

For lighting gas by electricity.

GALVANIZED STEEL GUY

WIRE.

**IRON ARC LAMP
CORDAGE.**



Very flexible, for use with pulleys.
Annealed and galvanized, with hemp center.

**GALVANIZED STEEL
WIRE. STRAND.**



**MOULDED RUBBER LAMP
CORD.**



Samson Cordage.



Electric Light Elevator Cable.



Rubber Covered Moulding Wire.



OKONITE WIRES AND CABLE

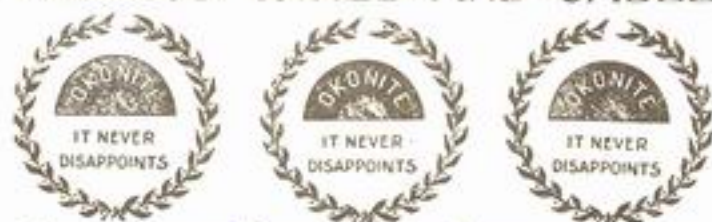

**For Low Tension Currents to
1500 Volts.**

Electric Light, Power and Railway Wires.

**For Medium Tension Current
to 3000 Volts.**

**For High Tension Currents
to 5000 Volts.**

Electric Light Power and Railway Wires.

For Underground Service.

Flexible Switch Cords.

For Electric Light, Power and Railway Use.

**Okonite Telephone and
Telegraph Wires.**

Metallic Circuits, Double Conductors,
Twisted Pairs.

**Telephone and Telegraph
Wires. Solid Single Conductor.**

Okonite Tubing.

	Approx. No. of Feet per lb.	Per pound.	List Price.
1/2 inch.	35	\$2.00
3/8 "	17	2.00
1/4 "	14	2.00
3/16 "	11 1/2	2.00
1/8 "	10	2.00
3/32 "	8	2.00
1/16 "	4 1/2	2.00
1/32 "	4	2.00
1/64 "	3	2.00

Soft Rubber Tubing.



Outside Diam.	Covers Wire No. 20, R. & S. G., Ins.	Approx. No. of Feet per lb.
1/2 inch.	No. 20, R. & S. G., Ins.	100, per lb.
3/4 "	" 14, " " "	50, " "
1 "	" 10, " " "	20, " "
1 1/4 "	" 6, " " "	15, " "
1 1/2 "	" 4, " " "	12, " "
2 "	" 0, " " "	9, " "

Hard Rubber Tubing.



IN LENGTHS OF 24 INCHES.

Outside Diam.	Inside Diam.	Approx. No. of Feet per lb.
1/2 inch.	1/4 inch.	20, per pound
3/8 "	1/8 "	11, " "
1/4 "	1/16 "	16, " "
3/16 "	1/32 "	10, " "
1/8 "	1/64 "	8, " "
3/32 "	1/128 "	8, " "
1/16 "	1/256 "	6, " "
1/32 "	1/512 "	6, " "

Battery Supplies.

Sal-Ammoniac.



IMPORTED.

Over 99 per cent pure.

List Price.

Per pound \$.20

Special price in barrel lots.

Blue Vitriol.



Per pound10

Special price in barrel lots.

CHEMICALS, METALS, Etc.

Bichromate Potash, per lb.....	.25
Chloride of Ammonia (Sal-ammoniac), per lb.....	.15
" " in casks, lowest market price	
Blue Vitriol, per lb.....	.10
" per bbl., lowest market price.	
Quicksilver (mercury), per lb.....	.90
Oxide of Zinc, per lb.....	.25
Sulphate of Zinc, per lb.....	.20
Paraffine, per lb.....	.20
Wax, for sealing batteries, per lb.....	.15

GLOBE BRUSH.

For cleaning arc lamp globes.



Price.

..... each, \$0.80

EMERY CLOTH.

For cleaning carbon rods in outside arc lamps

No	Price.
0	per quire, \$1.20
$\frac{1}{2}$	" 1.20
1	" 1.20
$1\frac{1}{2}$	" 1.20
2	" 1.50
$2\frac{1}{2}$	" 1.80

CARBON ROD BRUSH.



Price.

each, \$0.75

VITRO CHROME.

Incandescent lamp coloring.

Yellow. Red.

Amber. Green.

Purple. Blue.

8-oz. bottles, each, \$2.00

ZERO FROST.

mellow light pleasing to the eye.

8-oz. . . . each, \$2.00

CARBON BAG.

CARBON CASE.

For trimmers' use.



All leather, with shoulder

straps. Price.

..... \$2.75

Price.

All leather \$4.00

Tin. 2.00

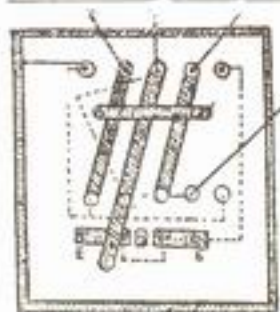

NO. 2



No. 13116.



No. 13112.

Switches.

Wood Base.



No. 13107.



No. 13105.



Union Lightning Arrester

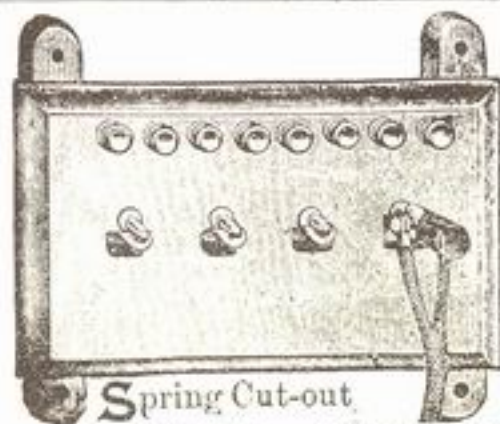

Spring Cut-out
4 -Wire, with plug and cord.

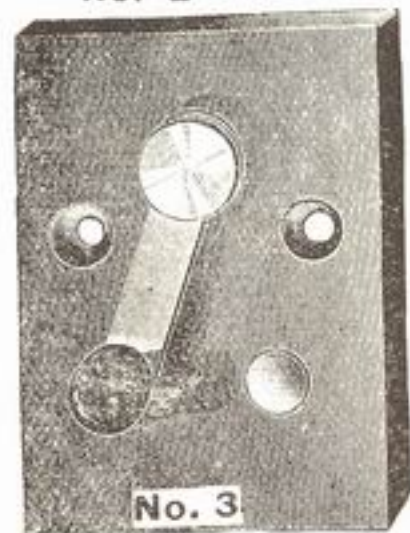

No. 3



NO. 5



TELEPHONE SWITCH



No. 13120.

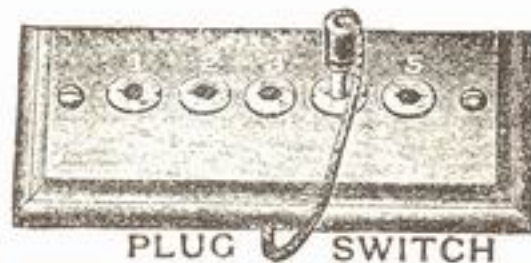

PLUG SWITCH



No. 13121.



No. 4

POLE CHANGING SWITCH.

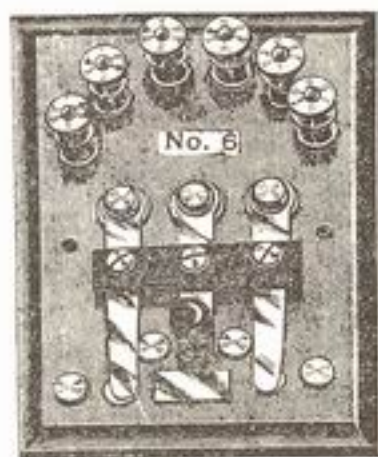

No. 6



No. 13125.



No. 13124.



Union Spring Cut-Out and Arrester.

BABY KNIFE SWITCHES.

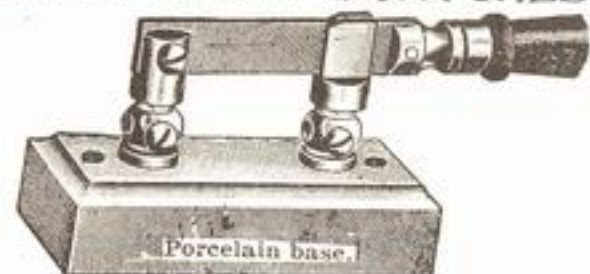

Ampere Capacity.			Price Each.
15	S. P.	S. T.	\$0.38
15	"	D. T.	.60
15	D. P.	S. T.	.50
15	"	D. T.	.95
15	3 wire.	S. T.	1.00
25	S. P.	"	.45
25	"	D. P.	.85
25	D. P.	S. T.	.60
25	"	D. T.	1.20
25	3 wire.	S. T.	1.25

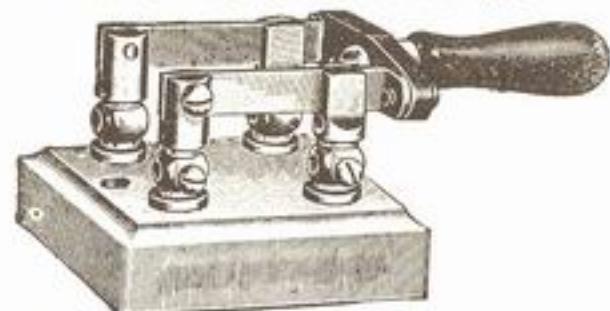

Ampere Capacity.			Price Each.
15	S. P.	S. T.	\$0.35
15	D. P.	S. T.	.40
25	"	"	.50

POLISHED KNIFE SWITCH.

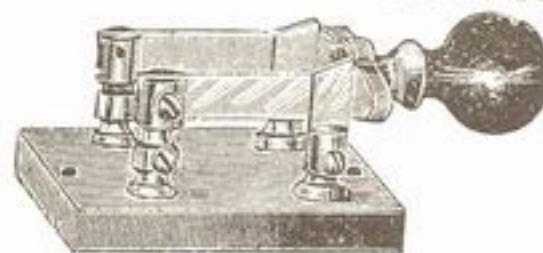

Ampere Capacity.			Price Each
15	S. P. S. T.		\$0.80
15	"	with fuse connection.	1.05
15	S. P. D. T.		1.50
15	"	with fuse connection.	1.65
15	D. P. S. T.		1.00
15	"	with fuse connection.	1.65

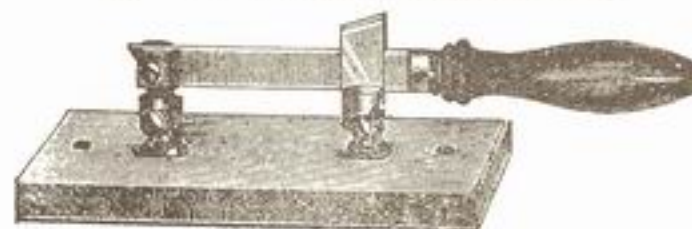

Single Pole, Single Throw.

Ampere Capacity	Slate bases.		Price	
	Without Fuse.	No.	With Fuse.	No.
25	\$0.95	13.	\$1.30	
50	1.45	25.	1.90	
75	1.80	37.	2.50	

Single Pole, Double Throw.

Ampere Capacity	Slate bases.		Price	
	Without Fuse.	No.	With Fuse.	No.
25	\$1.60	15.	\$2.20	
50	2.70	27.	3.55	
75	3.40	39.	4.50	

MICHIGAN SAFETY CATCH HOLDER.

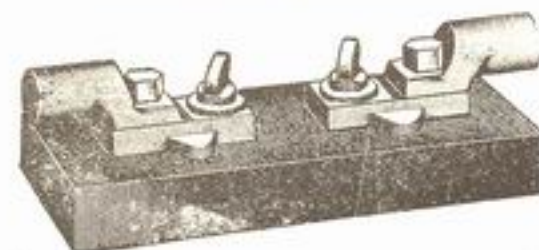

Capacity.	Price.
250 Amperes.....	each, \$2.40
400 ".....	" 3.50
600 ".....	" 6.00

MICHIGAN PLUG SWITCH.

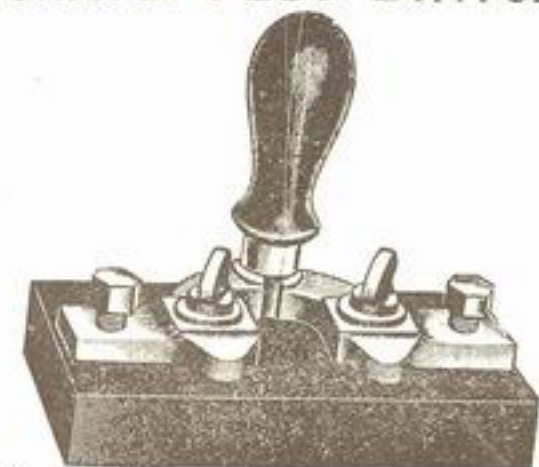

Capacity.	Price
250 Amperes.....	each, \$3.00
400 ".....	" 4.50
600 ".....	" 7.50

Facetten Solid Mica Bracket Joint.

Combination	IN MALLEABLE IRON	List Price
1/2 x 1/2, each		\$0.36
1/2 x 1/2, "		.36
1/2 x 1/2, "		.36
1/2 x 1/2, "		.50
1/2 x 1/2, "		.50
1/2 x 1/2, "		.50



Clamp Terminals.

For Incandescent Cord.

Per box of 25075

Canopies.

400	1/2 inch, Ring and Set Screw, each	.14
292	1/2 " " " " "	.14
294	1/2 " " " " "	.15
402	1 " " " " "	.15



388	1/2 inch, Ring and Set Screw, each	.24
293	1/2 " " " " "	.24
389	1/2 " " " " "	.26
391	1 " " " " "	.26



386	1/2 inch, Ring and Set Screw, each	.24
107	1/2 " " " " "	.24
328	1/2 " " " " "	.26
387	1 " " " " "	.26



Polished and Lacquered, 50% extra

Wire Guards.

	List Price
Polished Brass, per dozen	\$1.75
Tinned, per dozen	1.50



Cord Adjusters.



Wood, black enameled,

in 100 lots \$12.00

DOW CORD ADJUSTER



1. Hard rubber, in 100 lots.... \$9.00
1. Wood enameled, in 100 lots.... 7.50



Polished brass..... per doz. \$18.00
Nickel..... " 20.00



SOCKET HOOKS.



Threaded to fit 1/8 inch socket.... each, \$0.13

Socket bushings.



No. 3630.

Genuine Hard Rubber, 1/4 inch, per 1,000..... \$20.00
Composition, 1/4 inch, per 1,000..... 8.00



No. 3632.

Genuine Hard Rubber, 1/4 inch, per 1,000..... 22.50
Composition, 1/4 inch, per 1,000..... 9.00



No. 3634.

Genuine Hard Rubber, 1/4 inch, per 1,000..... 30.00
Composition, 1/4 inch, per 1,000..... 12.00



No. 3636.

Soft Rubber, per 1,000..... 7.00



No. 3637.

Genuine Hard Rubber, 1/4 inch, per 1,000..... 30.00



No. 2927.

Polished Brass and Hard Rubber Fixture Bushing, each..... .25

Regulating Socket.

A Money Saver.

A complete regulating socket for both alternating and direct current at 110 volts with 16 c. p. lamps. Has been fully tested by the most practical electricians in the United States. It has no rival in the electrical field to day, as it can be turned up and down from 2 c. p. to 16 c. p. the same as one would operate a gas jet, and will save 40 per cent of current when turned down. Finished in lacquered brass or antique copper. Price \$4.00

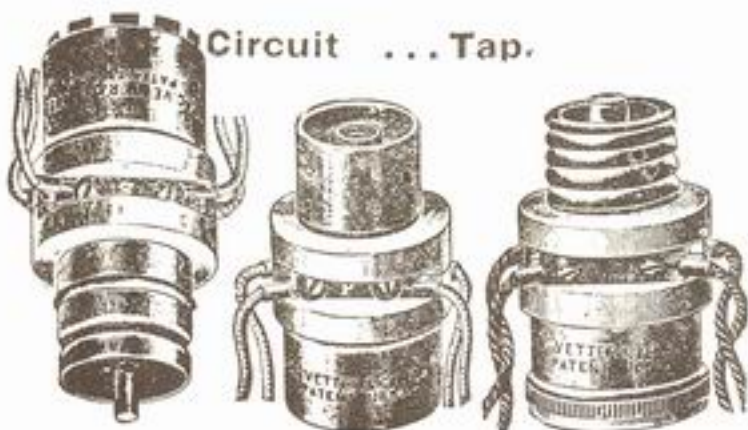

Price, \$3.00

Shade Holder for Cluster Lights.



Acme Shade Holder.

Will Fit Any Socket.

	Price.	Per dozen.
	2 1/4 in.	3 1/4 in.
1/2 in pipe..	\$2.88	\$3.60
3/8 " " ..	2.88	3 60
1/2 " " ..	2.88	3 60
1 " " ..	2.88	3 60



Socket Rings.



Hard Rubber Ring for Standard Edison Socket, each15
 Porcelain Ring for Standard Edison Socket, each, .10

Macallen Solid Mica Insulating Joint.

1x COMPOSITION BRASS.		
Combination.		
1x 1/2.	each.....	.50
1x 3/4.	"50
1x 1.	"50
1x 1 1/4.	"66 2/3
1x 1 1/2.	"66 2/3
1x 1 3/4.	"66 2/3
1x 2.	"66 2/3



Desk Portables.



Price.

Without reflector each, \$3.00

No. 759.



No. 760.

Height 18 inches with 24 inch extension. Finished in polished brass or gold.

Price.

.....each, \$5.00

COMBINATION BRACKET AND DESK LAMP.



Electric Lamps.

Can be Used as Stand or Bracket Lamp.

Price, \$6.00

**The Kinsman
ROLL TOP DESK LIGHT.**



Complete with socket,
Price,
each, \$9.00

Nickel plated, will take a 16 or 32 C. P. lamp.

**KINSMAN
PORTABLE
DESK LIGHT.**



C-S Flexible Bracket.

Length.	Price.
6 inch	\$1.00
9 "	1.10
12 "	1.25
15 "	1.50
18 "	1.85
24 "	2.50

No. 1 portable, nickel plated.
No. 1. Portable
each, \$12 00

Family Circle Lamp.



Makes a powerful concentrated light.
Price.
Complete with shade.....each, \$6.00

Desk Portable.



No. 1.

Stand natural wood finish, nickel plated frame.
Price.
Complete with N. P. hood.....each, \$3.25
" " hood green enameled.... " 3.00

Wall Brackets.



No. 61.

Scale, 1/2.	Price.
4-inch, per 100	\$14.00
6 " " 100	16 00
8 " " 100	20.00
10 " " 100	23.00
12 " " 100	27.50



No. 62.
Scale, 1/2.
Per 100.....\$35.00



Scale, 1/2.	Price.
4-inch, per 100	\$14.00
6 " " 100	16.00
8 " " 100	20.00
10 " " 100	23.00
12 " " 100	27.50



No. 55.
Scale, 1/2.
6-inch, per 100 \$36.00
10 " " 100 43 00

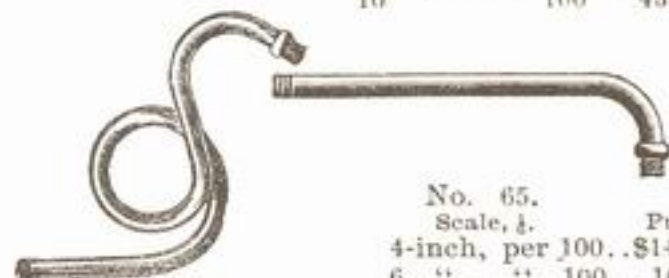

No. 57.
Scale, 1/2.
Price.
Per 100...\$35.00

Scale, 1/2.	Price.
4-inch, per 100..	\$14 00
6 " " 100..	16.00
8 " " 100..	20.00
10 " " 100..	23.00
12 " " 100..	27.50

THE ECLIPSE ANNUNCIATOR

Two Rows.

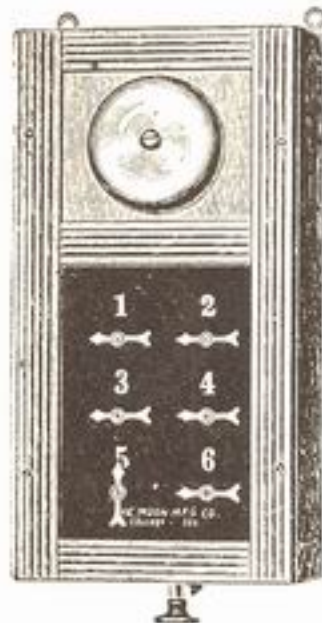

A high grade competition house annunciator.

Fully guaranteed.

Furnished in oak cases only.

		Price.
4 indicators	each,	\$4.45
6	" "	6.00
8	" "	7.00
10	" "	9.10
12	" "	10.70

The Eclipse. Style A House Annunciators.

TWO-POINT INDICATING BELL



Price.
Two-point.....\$2.50



Price.
Three-point.....\$3.50

Small Gravity Drop Annunciator.

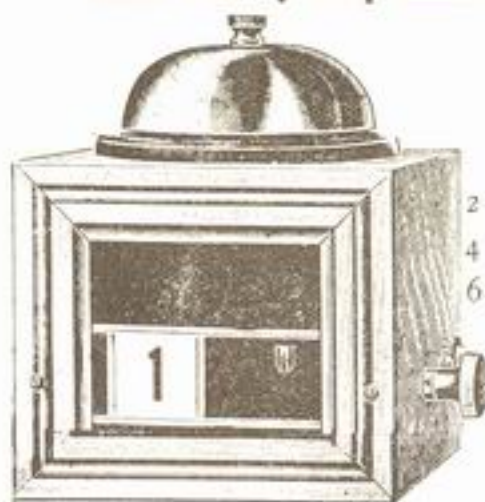

2 Drop, \$3.00
4 " 4.50
6 " 6.00

SELF-WINDING CLOCKS.

Length 40 inches;
width 16 inches.

Wound by electricity.
perfect clock for railroads,
stores, offices, residences,
perfect and reliable

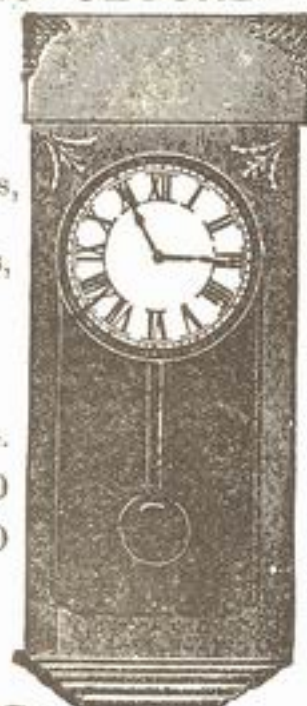

STYLE C.

Price.
Style C, complete \$40.00
" B, " 60.00

Pocket Galvanometer.



A handsomely finished and valuable little galvanometer, mounted in highly polished hard rubber case, with hard rubber cover.

Price.
Pocket galvanometer \$6.00

indicators.	Price.
2	\$4.00
3	4.50
4	5.00
5	6.50
6	7.00
8	9.00
10	11.00
12	13.20
14	15.40
16	17.60
18	19.80
20	22.00

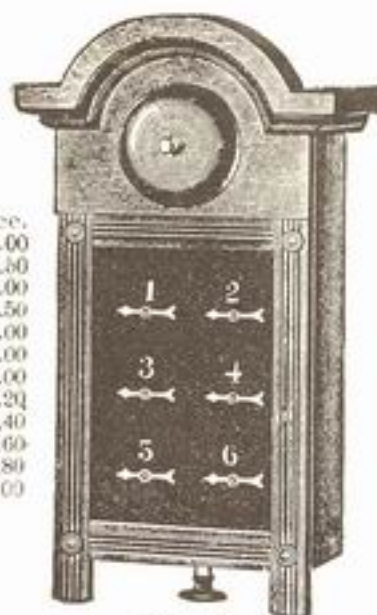

Style A.

The Duggan Cleat.



TWO WIRE.

Price.
Per 1000 Pair.

No. 1 and 3 holds wire No. 16 to No. 8,
in 1000 pair lots.....\$32.00
No. 2 holds wire No. 10 to No. 6, in
1000 pair lots..... 47.00

THREE WIRE.

Holds wire No. 16 to No. 8, in 1000
pair lots..... 35.00

Cleats, Wood.

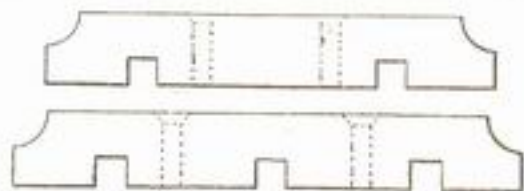

1	"	1/4	"	"	5.00
1	"	3/8	"	"	2.75
2	"	1/4	"	"	3.00
2	"	3/8	"	"	2.75
2	"	1/2	"	"	2.75
3	"	1/4	"	"	9.50

Fixture Cut-outs.



Hexagon, each..... .18

Midget S. P. per pair, .20



Medium D. P..... .20



Large D. P..... .20



Fixture Cut-outs.



List Price.

Straight (Long), each..... \$0.32



Quadrant, each..... .32



Midget, each..... .15



Midget, double pole, each..... .25

Bryant Covered Bug Cut-out.



complete, with cover, each .20

Edison Main and Branch Blocks with Mica Cover.



	Price each.
25 Ampere D. P. double branch cut-out.....	\$0.60
30 " S. P. main line cut-out.....	.50
30 " D. P. double branch cut-out.....	.90
30 " D. P. single branch cut-out.....	.60
75 " D. P. main line cut-out.....	.85
75 " D. P. double branch cut-out for wire up to No. 00 B. & S.....	4.00
75 Ampere D. P. double branch cut-out for wire up to No. 4 B. & S.....	\$2.00
30 Ampere D. P. single branch cut-out.....	.75
20 " 3-wire single branch.....	1.30
30 " 3-wire to 2-wire double branch.....	1.40
30 " 3-wire double branch.....	1.70
30 " 3-wire main cut-out.....	.70
75 " 3-wire main cut-out.....	1.30



EDISON PORCELAIN COVERED CUT-OUTS.

	Price each.
25 Ampere D. P. double branch cut-out.....	\$0.72
30 " S. P. main line cut-out.....	.55
30 " D. P. double branch cut-out.....	1.10
30 " D. P. single branch cut-out.....	.65
75 " D. P. main line cut-out.....	.95

K. W. Ceiling Rosette.

Cleat each20



Concealed, each20

Dovetail Rosettes—

for Moulding Work, each.....\$0.40



for Moulding Work, each..... .40



Combination Rosette.



Ceiling Button, per 100..... 2.50

Plain Rosette, No Fuse.

Plain Rosette, each.....\$0.15



Porcelain Ceiling Button.

1 1/4 inches in diameter, per 100..... 2.00



CENTRAL ROSETTE CUT-OUTS.

Price

Cleat..... each, 13c

Concealed... " 13c



Concealed.

Bryant Sockets.

T.-H. base, key.....	\$0.12 $\frac{1}{8}$
“ “ keyless... ..	.11 $\frac{7}{10}$
W. H. “ key.....	.12 $\frac{1}{8}$
“ “ keyless... ..	.11 $\frac{7}{10}$
Brush-Swan base key..	.23 $\frac{1}{8}$
“ “ “ keyless	.19 $\frac{1}{8}$



	Price.
T.-H. base, key, each	\$0.13
“ “ keyless, “	.12 $\frac{2}{10}$
W. H. “ key, “	.13
“ “ keyless, “	.12 $\frac{2}{10}$

Porcelain Keyless Receptacles.



For Clean Work.

For Thomson-Houston System, each.....	.25
“ Westinghouse “ “25
“ Edison “ “25

Attachment Plugs.

Attaching Plug, Edison Standard, plain, each....	.35
“ “ “ polished, each..	.40



Edison Sockets-

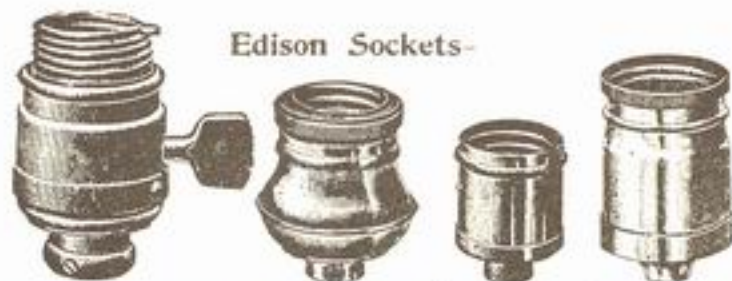

Key socket, with fiber ring .. each,	\$0.30
Keyless “ “ “ .. “	.26
Key “ “ removable rubber ring	.40
Keyless “ “ “ “	.33
“ “ acorn shell “	.40
“ “ for electrolier..... “	.40

Edison Key and Keyless Lamp Receptacles.



Keyless Wall Socket, polished, each.....	.45
Key Wall Socket, polished, each.....	.65
Key Wall Socket, plain, each45
Key Wall Socket, polished, each.....	.50
Keyless Wall Socket, polished, each.....	\$0.40

Shade Holder Receptacle.



Westinghouse Base, each	\$0.35
Edison Base, each.....	.35
Thomson-Houston Base, each.....	.35

Shade Holder Receptacle—Angle.



Edison Base, each.....	.50
Thomson-Houston Base, each.....	.50
Westinghouse Base, each50

Wall Socket Receptacles.



With Small Back for Edison Base, each.....	.30
“ “ Thomson-Houston Base, each	.30



With Large Back for Edison Base, each.....	.30
“ “ Thomson-Houston Base, each	.30



With Small Back and Screw for Edison Base, each	.30
“ “ “ Thomson-Houston Base, price.....	.30



404.



101.



171.

Soldering Coppers. Pointed.



Weight per pair, 1 1/4 lbs.	Price.
per pair, 1 1/4 lbs.	\$0.60
" " " 2 "	.80
" " " 3 "	1.20
" " " 4 "	1.60

Solder.



solder	per lb.	\$0.30
"	"	.30
"	"	.30

Yager's Soldering Salts.

Per 1/2 lb. bottle	Price.
Per 1/2 lb. bottle	\$0.60
" 1 "	.75
" 5 "	3.60



BLAST FURNACE.

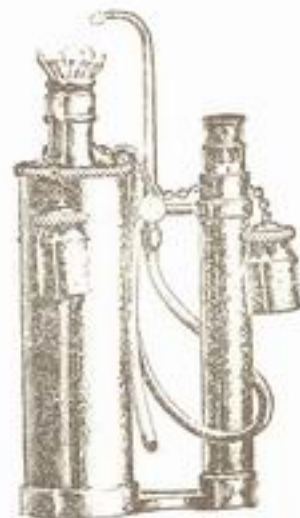

ALCOHOL TORCH.

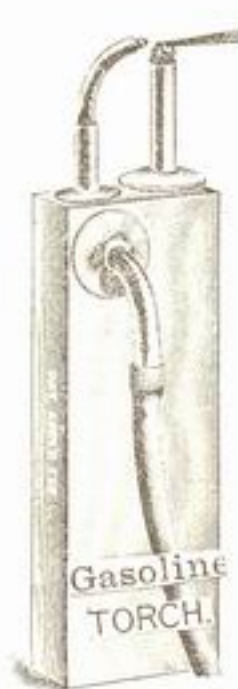

Gasoline TORCH.

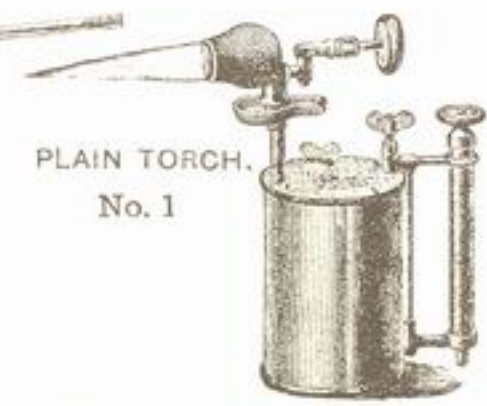

PLAIN TORCH. No. 1



HOT BLAST TORCH. No. 6



MELTING LADLES:



No. 3 SOLDERING COPPERS.



No. 4

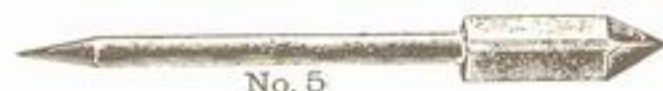

No. 5



MELTING POT.

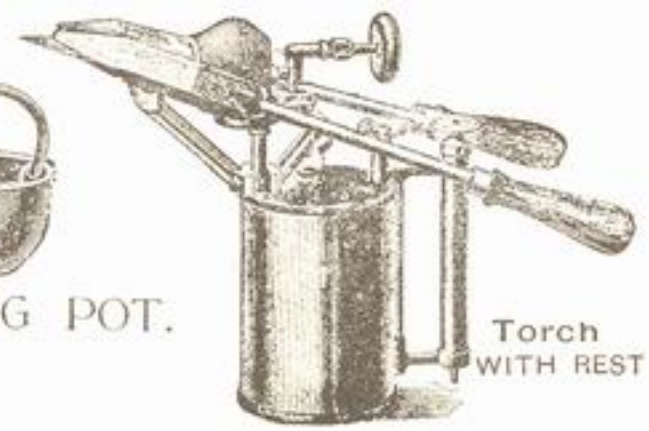

Torch WITH REST

THE BEARDSLEY MALLEABLE IRON PINS AND BRACKETS.

MALLEABLE IRON BRACKETS

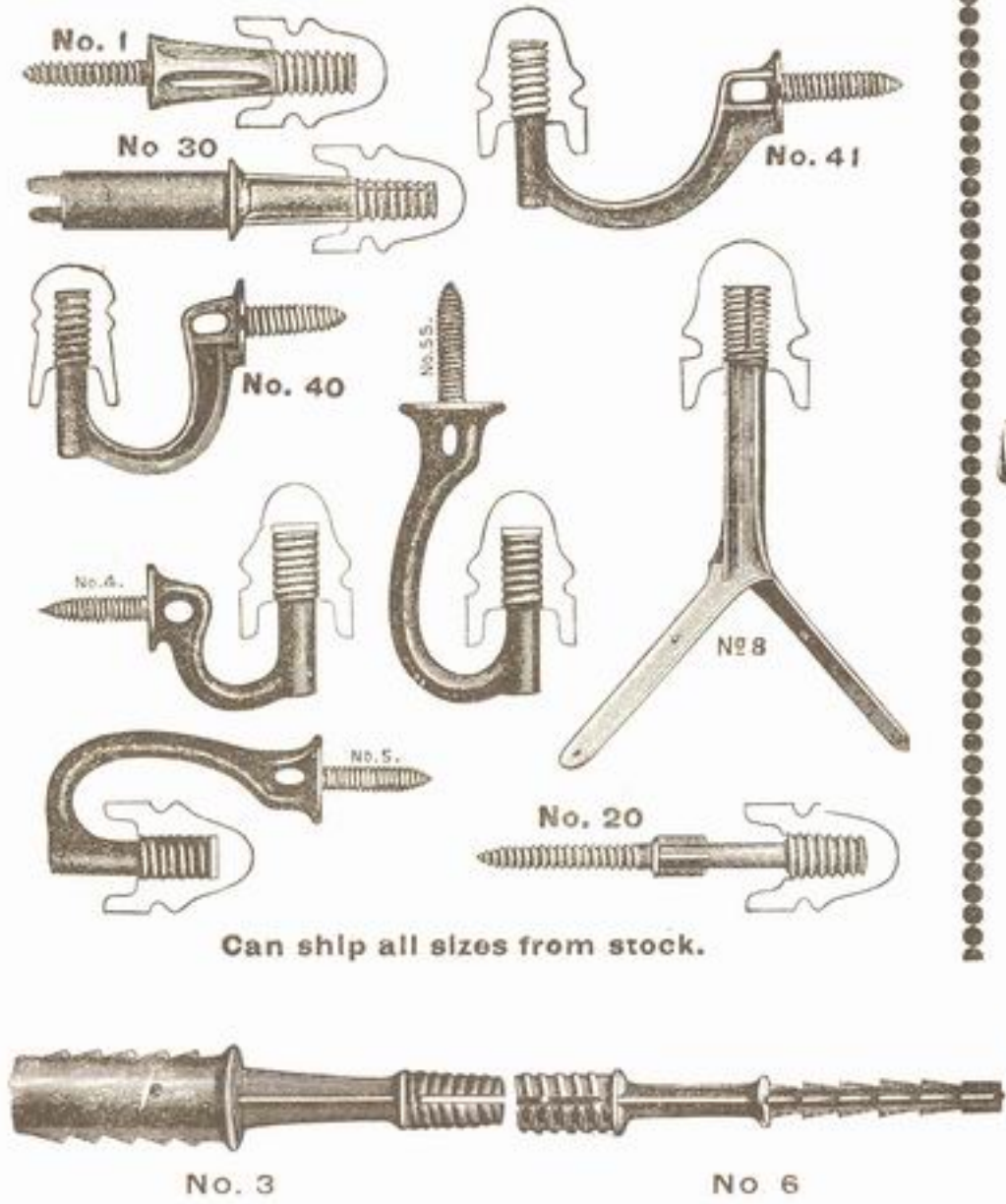

Can ship all sizes from stock.

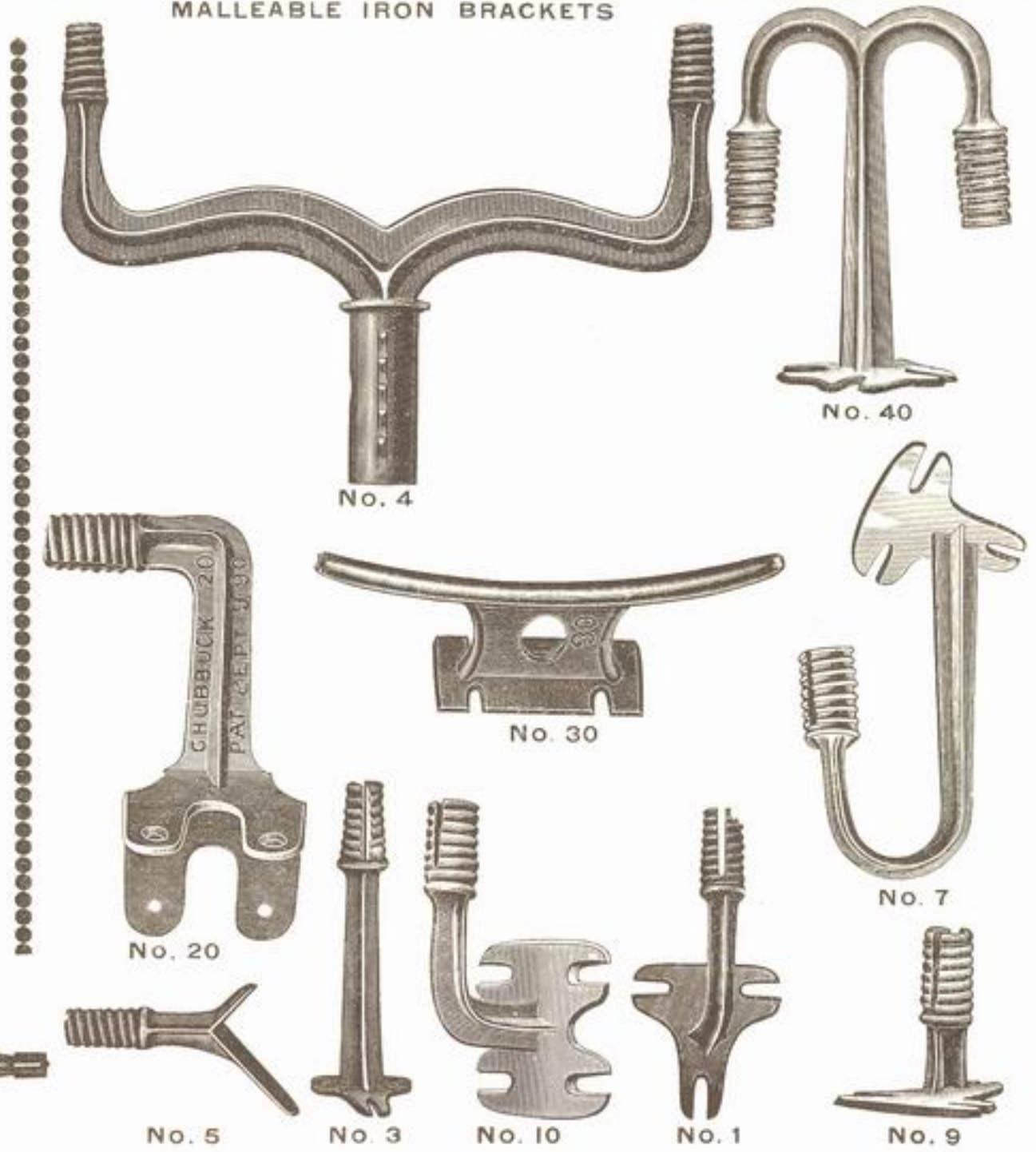

W. & M. High-Grade Double Galvanized Telephone Wire.

Full Stock of Wires on Hand.

Net Prices on Wire—Subject to change without notice.

Can Ship Extra BB---BB or Steel Wire from Chicago or Cleveland, Ohio, promptly.

We carry a stock of Commercial Galvanized Wire which gives good satisfaction.
It does the work, and is much cheaper.

Duplex Twisted Wires.



Style No. 1

Style 1. Made of No. 19 B. & S. Copper Wire, insulated to 3-32 inch, not covered with braid.

Style 2. Made up of No. 19 B. & S. Copper Wire, each conductor is made in a different color as a distinguishing feature for the convenience of the user. Conductors are not covered with braid.



Style No. 2



Style No. 3

Style 3. Made up in the same manner as Style No. 2, with the exception that it has one black braid covering the two conductors.

Style 4. Made up of No. 19 B. & S. Copper Wires, rubber covered, each conductor being covered with a braid and then twisted together. This is made up in Cherry, Oak, White and Black braid. A small distinguishing thread is run through one of the conductors as a distinguishing feature for the convenience of the user.



Style No. 4

We carry all the above Wire in stock and are prepared to make Immediate Shipment of same.

**INSULATED
RUBBER
WIRES AND CABLES.**



**LIGHT RUBBER-COVERED CABLES.
AERIAL CABLE RUBBER-COVERED
ANNUNCIATOR AND OFFICE WIRE
CABLES.**



**RUBBER-COVERED AND LEADED.
AERIAL (RUBBER-COVERED).**

Telephone Cable and Wire Department.

WE beg to state to our many friends and patrons, that owing to the limited space in our old quarters we were never able to give this Branch of the Telephone business the attention which we desired and which we believe it deserves. We are now making a special Department of Telephone Wires and Cables, under a competent manager, and we believe we will be able to give you as good, if not better, service in this line as you would receive elsewhere.

Telephone Cables.

CONDUCTORS twisted in pairs or laid parallel as specified, made of No. 19 B. & S. gauge, rubber insulated wire, covered with a single or double braid over all as required.

We can furnish these cables in any number of conductors that may be desired. As the number of wires needed, vary so largely in Cables, we do not make a list of same but are prepared to furnish them on very short notice. This also refers to Lead Covered Cables.

In ordering, or writing for quotations, kindly give us all the data possible.

INDEX.

	Page		Page		Page		Page
Arms Transmitter.....	12	Cord Adjusters.....	33	Hooks, Stationary.....	9	Receivers, Cords.....	10
American Storage Battery	16	Coils, Induction.....	9	Hooks, Socket.....	33	Receivers, Keelyn.....	10
Anti Hum.....	20	Coils, Repeating.....	9	Hydrometer Battery.....	17	Receivers, Watch Case Ex.	11
Annunciators.....	36	Coils, Ringer.....	9	Holder, Safety Catch.....	32	Receivers, Caps.....	11
Batteries, Storage.....	16	Coils and Gongs.....	9	Insulators, Glass.....	23	Receivers, Bobbin.....	26
Batteries, All kinds.....	15	Cross Arms.....	23-24	Insulators, Porcelain.....	23	Rosette.....	38
Battery Zinc.....	16	Cross Arm Braces.....	20-22	Iron Pins.....	42	Reels, Linemen.....	21
Battery Coppers.....	16	Cables, Telephone.....	44	Knobs, Porcelain.....	23-25	Resistance Rod.....	13
Battery Carbons.....	16	Cable, Electric Light.....	29	Lightning Arrester, Union	31	Sal Ammoniac.....	30
Battery Porous Cups.....	16	Cable, Terminals.....	13	Lightning Arrester, Carbon	14	Switch Plug Mich.....	32
Battery Syringe.....	17	Cable Clips.....	11	Lag Bolts.....	20-24	Switch Boards.....	5
Battery Brushes.....	17	Carbon Lightning Arrester	14	Linemen Safety Strap.....	20	Switch Board Weights.....	6
Battery Case.....	17	Carbon Disc.....	12	Linemen Tools.....	21	Switch Board Jacks.....	6
Battery Knife.....	17	Carbon Diaphragms.....	12	Linemen Bag.....	21	Switch Board Drops.....	6
Battery Call Outfit.....	17	Carbon, Granulated.....	12	Lamp Cord.....	29	Switch Board Plugs.....	6
Battery Gauge.....	17	Carbon Case.....	30	Lamps, Desk.....	34	Switch Board Cams.....	6
Battery Drop.....	9	Cart, Linemen.....	21	Lamps, Comb. Bracket.....	34	Switch Board Keys.....	6
Battery Hydrometer.....	17	Climbers.....	21	Magneto Drops.....	9	Switch Board Generators..	6
Bells, Magneto.....	7-8	Come Along.....	21	Magneto Medical Battery..	17	Switches, Wood Base.....	31
Bells, Extension.....	7-8	Chamois Skins.....	22	Magnet Winder.....	28	Switches, Baby Knife.....	32
Bells, Testing Linemen's..	7-8	Crocus Cloth.....	22	Medical Battery.....	17	Switches, Knife.....	32
Bells, Vibrating.....	18	Circuit Breaker.....	25	Mouth Pieces.....	11	Switches, Perkins.....	40
Bells, Monitor.....	18	Cordage, Samson.....	29	Mica Bracket Joint.....	33	Switches, Bryant.....	40
Boxes, Magneto.....	7	Canopies.....	33	Okonite Wire.....	29	Switches, Hart.....	40
Backboards.....	11	Clock, Self-winding.....	36	Okonite Tubing.....	29	Switches, Paiste.....	40
Buzzers, Battery.....	18	Cleats, Duggan.....	37	Oiler Sets.....	22	Syringe Battery.....	17
Buzzers, Magneto.....	9	Cleats, Wood.....	37	Push Buttons.....	26	Socket Bushings.....	33
Bolts, Lag.....	20	Distributing Board.....	14	Push, Table Clamp.....	26	Socket Hooks.....	33
Bolts, Carriage.....	25	Dynamo Hand.....	17	Push, Movable Floor.....	26	Socket, Regulating.....	34
Braces, Cross Arm.....	20	Drill, Long Twist.....	20-21	Pike Poles.....	21	Socket Rings.....	34
Belt, Linemen.....	20	Digging Bars.....	21	Plug attachment.....	39	Socket Receptacles.....	39
Bag, Linemen.....	21	Eye Bolts.....	22	Porous Cups.....	16	Sockets.....	39
Bag, Carbon.....	30	Emery Cloth.....	30	Poles, Cedar.....	25	Staples, Electricians.....	20
Brush, Carbon Rod.....	30	Fuse, Terminal Box.....	13	Pole Steps.....	24-25	Screw Drivers.....	20
Brush, Globe.....	30	Fuse, Wire Terminal.....	13	Pins, Oak.....	23-24	Shears, Linemen.....	21
Boring Tool.....	21	Fuses for Cable Box.....	13	Pins, Iron.....	42	Shovels.....	21
Brackets, Iron.....	42	Fuse Blocks.....	14	Pulley Blocks.....	21-22	Spades.....	21
Brackets, Oak.....	23-24	Fuse Micacs.....	14	Pole Protector Strip.....	22	Splicing Clamps.....	21
Binding Posts.....	26-27	Gongs.....	18	Pliers.....	21	Shade Holders.....	34-39
Bobbins, Receiver.....	26	Guy Rods.....	22	Raising Forks.....	21	Solder Bar.....	41
Blue Vitriol.....	30	Guy Clamps.....	21	Receivers.....	10	Solder Wire.....	41
Burglar Alarm Attachm'ts	27	Glass Insulators.....	23	Receivers, Watch Case.....	10	Solder Salts, Yager.....	41
Bushings, Sockets.....	33	Galvanometer.....	36	Receivers, Shell.....	10	Solder, Stick, Allen.....	41
Cut Outs.....	31-37-38	Hooks, Switches.....	9	Receivers, and Head Band	10	Solder Flux.....	41

TELEPHONES
AND
ELECTRICAL SUPPLIES



Farr Telephone and Construction Supply Co.

CHICAGO